

# Laserliner



Feel  
good

## KONTROLLER LUFTEN, DU INDÅNDER

 INFOS >



**4 YEARS WARRANTY**  
**JAHRE GARANTIE**  
CERTIFIED DESIGN AND QUALITY

For apparater udgør garantitiden 4 år fra købsdato. Undtaget herfra er akkuer og tilbehør.

Yderligere informationer på [www.laserliner.com/garantie](http://www.laserliner.com/garantie)

Forbehold for ændringer i farve, design, sætkombinationer og produktafbildninger samt tekniske forbedringer. Uden ansvar for oplysningernes rigtighed. Uden ansvar for oplysningernes rigtighed. Billedarkiver: UMAREX Laserliner, Shutterstock

[www.health-and-home.info](http://www.health-and-home.info)



### BAIER SCANDINAVIA APS

Topstykket 29,  
DK-3460 Birkerød  
tlf.: +45 4594 2200  
[baier@baier.dk](mailto:baier@baier.dk)  
[www.laserliner.dk](http://www.laserliner.dk)

020.22.081DA  
Rev22W41/1.000

UMAREX GmbH & Co. KG – Laserliner – Donnerfeld 2 59757 Arnsberg, Germany  
Tel. +49 2932 638-300 [info@laserliner.com](mailto:info@laserliner.com) [www.laserliner.com](http://www.laserliner.com)

## KONTROLLER LUFTEN, DU INDÅNDER

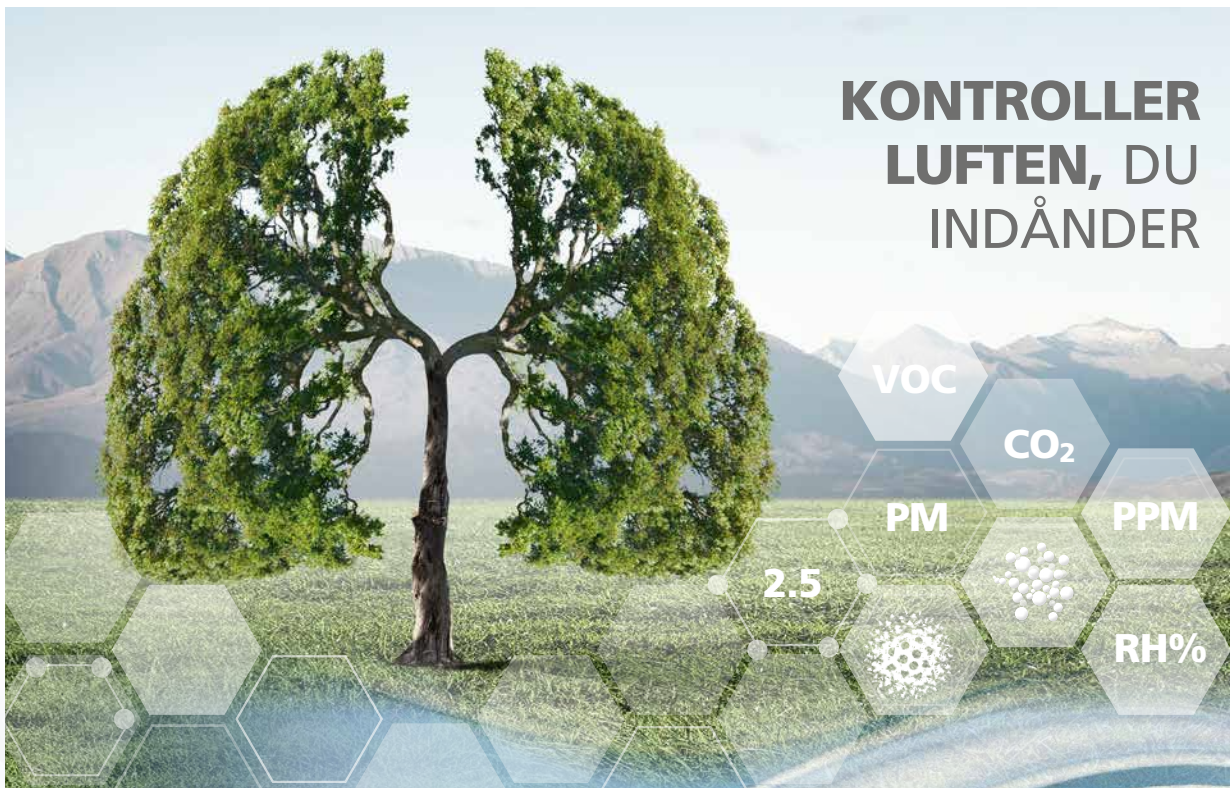

 **AIR QUALITY** MÅLEAPPARATER  **AIRBREEZE** LUFTRENSERE



### **FEEL GOOD. Med sundheden for øje.**

Vores måleapparater til luftbårne partikler, CO<sub>2</sub>, luftfugtighed og organiske stoffer er ideelle hjælpere, når der er tale om at skabe et sundt indeklima. De beskytter effektivt mod hovedpine, træthed og almindeligt ubehag ved registrering og advarsel mod for høj kuldioxidkoncentration, farlige luftforurenende stoffer eller enfor høj luftfugtighed.





HEALTH

CO<sub>2</sub>

AIR

CLIMA

IDEEL TIL ALLERGIKERE

PM 2.5  
PM 10

## ALLERGY INDOOR DETECTOR AIRMONITOR PURE

Præcist måleapparat til luftbårne partikler med advarsel mod sundhedsfarlige koncentrationer.

- ◆ Effektiv måling af luftbårne partikler i kategorien PM 2.5 (industriudstødningsemissioner) og PM 10 (pollen og allergener fra planter og blomster).
- ◆ Optimal nøjagtighed med en schweizer præcisionssensor.
- ◆ Optisk og akustisk advarsel mod for høj aerosolkoncentration i rummet.
- ◆ Visning af luftfugtighed, temperatur og klokkeslæt.
- ◆ Night-modus: Lysdæmpning af displayet om natten.

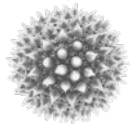
PM 2.5  
STATUSPM 10  
STATUSCOLOUR  
ALARM



HEALTH

CO<sub>2</sub>

AIR

CLIMA

MED VENTILATIONSANBEFALING



**CO<sub>2</sub> INDOOR DETECTOR**  
**AIRMONITOR CO<sub>2</sub>**

CO<sub>2</sub>-måler til nøjagtig beregning og analyse af kuldioxidkoncentrationen, inklusive ventilationsanbefaling.

- ◆ Effektiv måling og evaluering af CO<sub>2</sub>-koncentrationen i rumluften inde.
- ◆ Perfekt nøjagtighed med en schweizer præcisionssensor (NDIR CO<sub>2</sub>).
- ◆ Optiske og akustiske signaler advarer mod for høj CO<sub>2</sub>-koncentration.
- ◆ Ventilationsanbefaling til forbedring af indeklimaet.
- ◆ Visning af luftfugtighed, temperatur og klokkeslæt.
- ◆ Night-modus: Lysdæmpning af displayet om natten.





HEALTH

CO<sub>2</sub>

AIR

CLIMA

TIL DEN BEDSTE LUFT INDENDØRS

VOC  
CO<sub>2</sub>

DIY-OPGAVER



BOLIGOMRÅDE

## AIR QUALITY INDOOR DETECTOR AIRMONITOR FRESH

Præcist måleapparat til registrering af skadelige organiske forbindelser i luften (VOCs), med visning af CO<sub>2</sub>-koncentration og ventilationsanbefaling.

- ◆ Måling og advarsel mod organiske forbindelser som effektiv sundhedsbeskyttelse ved anvendelse af rengøringsmidler, farver, lakker, kunststoffer og håndværksarbejder som maling, slibning, savning og boring.
- ◆ Perfekt nøjagtighed med en schweizisk præcisionssensor.
- ◆ Ventilationsanbefaling til forbedring af indeklimaet.
- ◆ Visning af luftfugtighed, temperatur og klokkeslæt.
- ◆ Night-modus: Lysdæmpning af displayet om natten.

VOC  
STATUSCO<sub>2</sub>  
STATUSCOLOUR  
ALARM



HEALTH

CO<sub>2</sub>

AIR

CLIMA

MED TIMERFUNKTION



SOVEVÆRELSE



BADEVÆRELSE/WC

## HUMIDITY INDOOR DETECTOR AIRCHECK CLIMA

Digitalt hygrometer med ventilationsanbefaling og positiv indflydelse på sundhed og boligkomfort.

- ◆ Præcis måling af den relative luftfugtighed og omgivelsestemperatur og lagring af min./maks. Værdier.
- ◆ Optiske og akustiske advarsel mod for høj luftfugtighed og lufttørhed.
- ◆ Hjælper ved forebyggelse af fugtskader.
- ◆ Til opstilling som bordapparat, ophængning på væg og magnetisk montering på metaloverflader.
- ◆ Visning af temperatur og klokkeslæt.



> 65 %



< 30 %



**AIRMONITOR PURE****AIRMONITOR CO<sub>2</sub>****AIRMONITOR FRESH****AIRCHECK CLIMA****MÅLEOMRÅDER**

- Koncentration luftbårne partikler PM 2.5 / PM 10
- Luftfugtighed
- Omgivelsestemperatur

- Kuldioxidkoncentration (CO<sub>2</sub>)
- Luftfugtighed
- Omgivelsestemperatur

- Flygtige organiske forbindelser (VOC)
- Kuldioxidkoncentration (CO<sub>2</sub>)
- Luftfugtighed
- Omgivelsestemperatur

- Luftfugtighed
- Omgivelsestemperatur

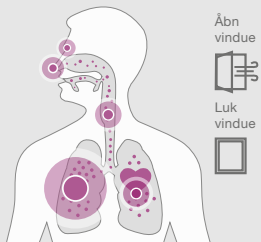
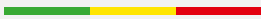
**OPTISK ADVARSEL**

Åbn vindue



Luk vindue

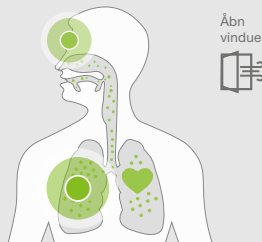

Åbn vindue

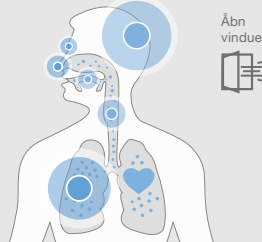

Åbn vindue

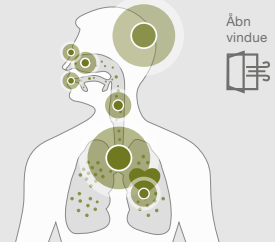

Åbn vindue

**SYMPTOMER**

- Irritation af luftvejene
- Allergiske reaktioner
- Svækkelse af hjerte-kar-systemet
- Irritation af slimhinder i øjne, næse og svælg

- Forhøjelse af åndedrætsfrekvensen
- Træthed
- Indskrænkning af den intellektuelle ydeevne
- Bronkitis

- Ændret lugt- og smagssans
- Irritation af øjne eller slimhinder
- Koncentrationsbesvær, udmattelse, tør hud, eksem og hovedpine
- Bronkitis og astma

- VED SKIMMELVÆKST PÅ GRUND AF FOR HØJ LUFTFUGTIGHED
- Irritation af luftvejene
  - Hovedpine
  - Lunge- og hjertesygdomme

- PÅ GRUND AF FOR HØJ LUFTTØRHED
- Tør hoste
  - Øjenirritationer
  - Tør mund og svælg

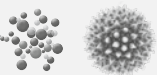

ART.-NR. 082.431A  
EAN 4021563718627

ART.-NR. 082.427A  
EAN 4021563717453

ART.-NR. 082.430A  
EAN 4021563718610

ART.-NR. 082.432A  
EAN 4021563722013

**ANVENDELSESOMRÅDER** boligejendomme, kontorbygninger, børnehaver, skoler og offentlige bygninger



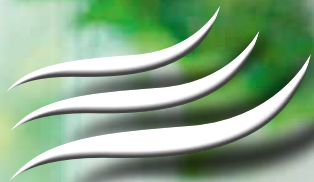

**GOD BESKYTTELSE MOD  
POLLEN, DYREHÅR OG  
VIRA.**



## AIRBREEZE. Til et sundt indeklima.

Med vores luftrensere forbedrer du indeklimaet og dermed din livskvalitet. De stærke **AirBreeze-modeller** råder over effektive 3 i 1-filtre bestående af forfilter, HEPA13-filter samt aktiv kulfilter og befrier luften for forureninger som aerosoler, husstøv og mikrohår fra husdyr. Andre funktioner er reducere pollenkoncentrationen, neutralisering af ubehagelige lugte og inaktivering af vira og bakterier. Igennem 4 indstillelige effektrin, lav DB ved drift og et attraktivt udseende overbeviser apparaterne med mange anvendelsessteder som f.eks. i boligen og på kontoret.



Luftbårne  
Partikler

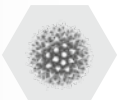

Pollen



Dyrehår



Lugte



Vira

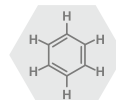

Benzol



Formaldehyd



Røg

**RENSER 99.997%\***  
**AF DE SKADELIGE**  
**STOFFER I LUFTEN**

\***HEPA13 FILTER**  
renser 99,997%  
af alle skadelige  
stoffer større end  
0,3 mikrometer





**AIRBREEZE**

**120**

360UV

510UV

FILTER



**30m<sup>2</sup>**

MAKSIMAL RUMSTØRRELSE\*

**120m<sup>3</sup>/h**

CADR CLEAN AIR DELIVERY RATE

## INDOOR AIR PURIFIER

# AIRBREEZE 120

Kompakt, stærk luftrensner med effektivt HEPA13-filter til rum på op til 30 kvadratmeter.

- ◆ Rent og sundt indeklima takket være luftrensning med effektivt 3 i 1-filter (forfilter/HEPA13-filter/aktivt kulfilter).
- ◆ Effektiv fjernelse af fine PM 2.5-støvpartikler, husstøv og mikrohår fra husdyr.
- ◆ Pålidelig neutralisering af ubehagelige lugte.
- ◆ 4 indstillelige effektrin.
- ◆ Støjsvag dvaletilstand (20 dB (A)) inkl. mørkt display.
- ◆ Trendy og kompakt design til anvendelse som bordapparat.

## TIMER-FUNKTION

🕒 1 / 2 / 4 / 8 timer



**PM 2.5**  
FILTRATION

**POLLEN**  
FILTRATION

**HEPA13 +**  
AKTIV KULFILTER



**HIGH PERFORMANCE**



LUFTBÅRNE  
PARTIKLER

SMOG



BØRNESIK-  
RING

**LED-DISPLAY**

med farvevisning af luftkvaliteten



Status  
luftkvalitet



PERFEKT    GOD    NORMAL    DÅRLIG

**HEPA13-FILTER**

+ Integrering af aktiv kulfilter til  
lugtneutralisering



i  
Side 14

**IDEEL TIL ALLERGIKERE**



POLLEN

HUSSTØV

DYREHÅR



**360° FRESH AIR**

360° luftcirkulation  
4 lufttrin



**PERFEKT TIL KONTORET**



**MANGE ANVENDELSESMULIGHEDER**  
f.eks. soveværelse, stue og arbejdsværelse

\*beregnet iht. NRCC-54013-2011 på grundlag af CADR-værdien iht. GB/T8801-2015



**AIRBREEZE 120**

**360UV**

**510UV**

**FILTER**



## INDOOR AIR PURIFIER

### AIRBREEZE 360UV

#### AIRBREEZE 360UV / 510UV

Højtydende luftrensere med HEPA13-filer til maksimale rumstørrelser på 80 kvadratmeter.

- ◆ Ideel til boliger eller kontorer.
- ◆ Rent og sundt indeklima takket være luftrensning med effektivt 3 i 1-filter (forfilter/HEPA13-filter/aktivt kulfilter)
- ◆ Effektiv fjernelse af fine PM 2.5-støvpartikler, husstøv og mikrohår fra husdyr.
- ◆ Farvet og numerisk visning af PM 2.5-status.
- ◆ Pålidelig neutralisering af ubehagelige lugte
- ◆ Infektionsrisikoen reduceres, da vira og bakterier stort set deaktiveres.
- ◆ 4 indstillelige effekttrin.

## TIMER-FUNKTION

🕒 1 / 4 / 8 timer





**AIRBREEZE 120**

**360UV**

**510UV**

**FILTER**



**110m<sup>2</sup>**

MAKSIMAL RUMSTØRRELSE\*

Laserliner

**510m<sup>3</sup>/h**

CADR CLEAN AIR DELIVERY RATE

## AIRBREEZE 510UV

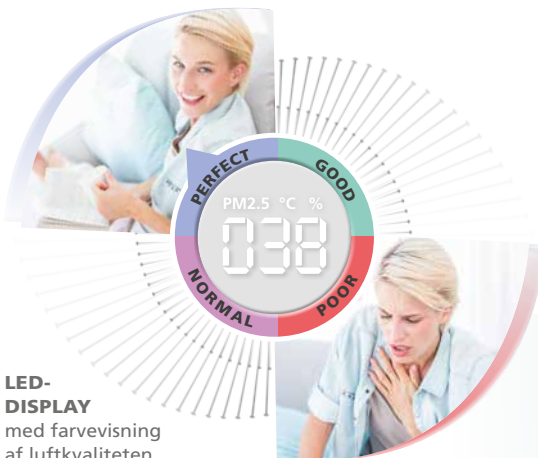

**LED-DISPLAY**  
med farvevisning af luftkvaliteten

**HEPA13**  
Filter  
**AKTIV KULFILTER**



Side 14



**UV-C STRÅLING**  
inaktiveret til 99,99% bakterier og vira.



### IDEEL TIL ALLERGIKERE

DYREHÅR

POLLEN

HUSSTØV

LUFTBÅRNE PARTIKLER



### SÆRLIG LYDSVAG



20 dB(A)



### SOVEMODUS

Også om natten den bedste luftkvalitet.



**PM 2.5**  
FILTRATION



**POLLEN**  
FILTRATION



**VIRUS**  
BESKYTTELSE



**HEPA13 +**  
AKTIV KULFILTER

\*beregnet iht. NRCC-54013-2011 på grundlag af CADR-værdien iht. GB/T8801-2015

## AIRBREEZE 120 | 360UV | 510UV | FILTER

### AIR PURIFIER ACCESSORIES

#### AIRBREEZE 120 FILTER

Luftrensingsfilter til AirBreeze 120-serien

#### HEPA13-FILTER

rensner 99,997% af alle skadelige stoffer større end 0,3 mikrometer



POLLEN

DYREHÅR

LUFTBÅRNE PARTIKLER

HUSSTØV



#### INTEGRERET AKTIV KULFILTER

Absorberer lugte

RØG

LUGTE

GASSER

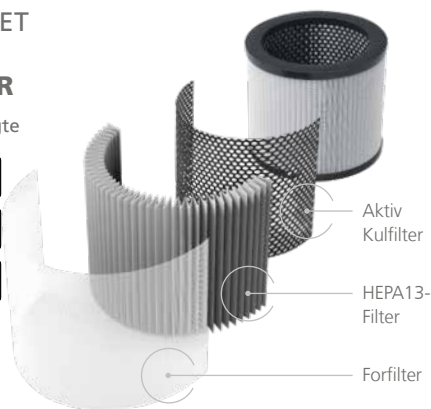

1 STK.

AIRBREEZE  
**120**

**HEPA13**  
BESKYTTELSE

NEUTRALISERING  
AF LUGTE

#### AIRBREEZE 360 FILTER-SET

#### AIRBREEZE 510 FILTER-SET

Luftrensingsfilter til AirBreeze 360 og 510-serien

#### HEPA13-FILTER

rensner 99,997% af alle skadelige stoffer større end 0,3 mikrometer



POLLEN

DYREHÅR

LUFTBÅRNE PARTIKLER

HUSSTØV



#### AKTIV KULFILTER

Absorberer lugte

RØG

LUGTE

GASSER

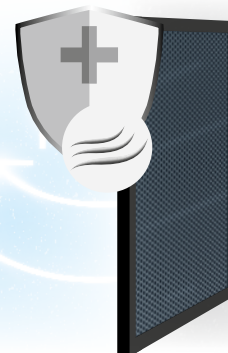

AIRBREEZE  
**360**

AIRBREEZE  
**510**

**HEPA13**  
BESKYTTELSE

NEUTRALISERING  
AF LUGTE

2 STK.

**AIRBREEZE 120**

Luftbårne partikler PM 2.5

Pollen

Dyrehår

**MÅLESTØRRELSE**

- Koncentration luftbårne partikler PM 2.5

**OPTISK ADVARSEL**

PERFEKT GOD NORMAL DÅRLIG

**MAKSIMAL RUMSTØRRELSE\*****30m<sup>2</sup>**

CADR\*\* NATMODUS\*\*\*  
**120 m<sup>3</sup>/h 20dB(A)**

MÅL VÆGT  
 225 x 310 x 225 mm 2,5 kg

TOUCH-BETJENINGS-FELT



ART. / EAN 085.120A / 4021563725151

**AIRBREEZE 120 FILTER**

1 STK.

MÅL VÆGT  
 Højde 153 x Ø 175 mm 400 g

ART. / EAN 085.121A / 4021563725168

**AIRBREEZE 360UV**

Luftbårne partikler PM 2.5

Pollen

Dyrehår

Anti virus 1 x UV-C lys

- Koncentration luftbårne partikler PM 2.5
- Luftfugtighed
- Omgivelsestemperatur

PERFEKT GOD NORMAL DÅRLIG

**80m<sup>2</sup>**

CADR NATMODUS  
**360 m<sup>3</sup>/h 20dB(A)**

MÅL VÆGT  
 410 x 630 x 210 mm 7 kg



ART. / EAN 085.360A / 4021563724581

**AIRBREEZE 360 FILTER-SET**SET  
2 STK.

MÅL VÆGT  
 390 x 280 x 46 mm 650 g

ART. / EAN 085.361A / 4021563724925

**AIRBREEZE 510UV**

Luftbårne partikler PM 2.5

Pollen

Dyrehår

Anti virus 1 x UV-C lys

- Koncentration luftbårne partikler PM 2.5
- Luftfugtighed
- Omgivelsestemperatur

PERFEKT GOD NORMAL DÅRLIG

**110m<sup>2</sup>**

CADR NATMODUS  
**510 m<sup>3</sup>/h 20dB(A)**

MÅL VÆGT  
 460 x 710 x 230 mm 10 kg

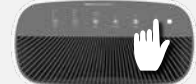

ART. / EAN 085.510A / 4021563724598

**AIRBREEZE 510 FILTER-SET**SET  
2 STK.

MÅL VÆGT  
 420 x 300 x 60 mm 1200 g

ART. / EAN 085.511A / 4021563724932