

# PrecisionPlane-Laser 3D Pro



**SENSOR**  
AUTOMATIC

 Laser  
635 nm

 ANTI  
SHAKE

 PowerBright+  
LASER

 lock

 RX  
READY

1H360° 2V360°

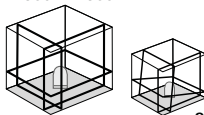

DE 02

EN 13

NL 24

DA 35

FR 46

ES 57

IT

PL

FI

PT

SV

NO

TR

RU

UK

CS

ET

LV

LT

RO

BG

EL

**Laserliner®**



Lesen Sie vollständig die Bedienungsanleitung und das beiliegende Heft „Garantie- und Zusatzhinweise“. Befolgen Sie die darin enthaltenen Anweisungen. Diese Unterlage ist aufzubewahren und bei Weitergabe der Lasereinrichtung mitzugeben.

## Funktion / Verwendung

Dreidimensionaler Laser mit drei roten 360°-Laserkreisen und adaptierbarem Metall-Sockel

- Zusätzliche Neigungsfunktion zum Ausrichten von Schrägen
- Motorische Verstellung von  $\pm 2^\circ$  möglich
- Out-Off-Level: Durch optische Signale wird angezeigt, wenn sich das Gerät außerhalb des Nivellierbereichs befindet.
- Adaptierbarer Metall-Sockel zur exakten Positionierung der Laserlinien durch das drehbare Gehäuse mit Seitenfeintrieb.
- Selbstnivellierbereich  $2^\circ$ , Genauigkeit 0,15 mm / m

## Allgemeine Sicherheitshinweise

- Setzen Sie das Gerät ausschließlich gemäß dem Verwendungszweck innerhalb der Spezifikationen ein.



Laserstrahlung!  
Nicht in den Strahl blicken!  
Laser Klasse 2  
< 1 mW · 635 nm  
EN 60825-1:2014

- Achtung: Nicht in den direkten oder reflektierten Strahl blicken.
- Den Laserstrahl nicht auf Personen richten.
- Falls Laserstrahlung der Klasse 2 ins Auge trifft, sind die Augen bewusst zu schließen und der Kopf sofort aus dem Strahl zu bewegen.
- Betrachten Sie den Laserstrahl oder die Reflektionen niemals mit optischen Geräten (Lupe, Mikroskop, Fernglas, ...).
- Verwenden Sie den Laser nicht auf Augenhöhe (1,40 ... 1,90 m).
- Gut reflektierende, spiegelnde oder glänzende Flächen sind während des Betriebes von Lasereinrichtungen abzudecken.

- In öffentlichen Verkehrsbereichen den Strahlengang möglichst durch Absperrungen und Stellwände begrenzen und den Laserbereich durch Warnbeschilderung kennzeichnen.
- Manipulationen (Änderungen) an der Lasereinrichtung sind unzulässig.
- Dieses Gerät ist kein Spielzeug und gehört nicht in die Hände von Kindern.

## Besondere Produkteigenschaften



Automatische Ausrichtung durch elektronische Libellen und Servomotoren mit temperaturstabiler Sensorik. Das Gerät wird in Grundstellung gebracht und richtet sich selbständig aus.



Diese Funktion ist automatisch aktiv, wenn die Sensor-Automatic eingeschaltet ist. Damit wird das horizontale bzw. vertikale Nivellieren erleichtert, z.B. um den Laser mit einem Kurbelstativ oder einer Wandhalterung auf eine gewünschte Höhe einzustellen. Zudem kann auf vibrierenden Untergründen und bei Wind nivelliert werden.



Transport LOCK: Eine Pendelarretierung schützt das Gerät beim Transport.



Spezielle Hochleistungsdioden erzeugen noch hellere Laserlinien als Geräte mit PowerBright-Technologie. Diese bleiben sichtbar auf längere Entfernungen, bei hellem Umgebungslicht und auf dunklen Oberflächen.



Mit der RX-READY-Technologie können Linienlaser auch bei ungünstigen Lichtverhältnissen verwendet werden. Die Laserlinien pulsieren dann mit einer hohen Frequenz und werden durch spezielle Laserempfänger auf große Entfernungen erkannt.

## Anzahl und Anordnung der Laser

H = horizontale Laser

V = vertikale Laser

S = Neigungsfunktion

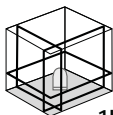

1H360° 2V360°



S



- 1 Laseraustrittsfenster
- 2 Akkufach (Unterseite)
- 3 Anschlussbuchse für Netzteil (12 V/2000 mA, keine Ladefunktion)



- 4 5/8" -Stativgewinde (Unterseite)
- 5 5/8" Gewindestück
- 6 frei beweglicher Sockel
- 7 Dosenlibelle
- 8 Justierfüße
- 9 5/8" -Stativgewinde
- 10 Arretierung
- 11 Feststellschraube Gewindestück
- 12 Seitenfeintrieb

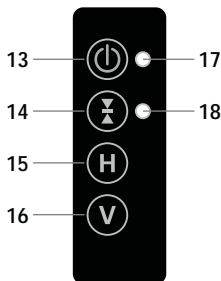

- 13 AN/AUS-Taste
- 14 Handempfängermodus ein / aus / Neigungsfunktion ein
- 15 Horizontale Laserlinie
- 16 Vertikale Laserlinien
- 17 LED Betriebsanzeige / Automatikbetrieb (LED blinkt in der Einrichtphase)
- 18 LED Handempfängermodus / LED Neigungsfunktion

## 1 Handhabung Lithium-Ionen Akku

Vor dem ersten Einsatz den Akku vollständig aufladen. Dazu den Akku in das mitgelieferte Ladegerät einlegen. Dabei auf korrekte Einschubrichtung achten. Während der Akku geladen wird, leuchtet die LED des Ladegerätes rot. Der Ladevorgang ist abgeschlossen, wenn die LED grün leuchtet. Sobald die LED's (17) und (18) blinken, ist die Batterieladung schwach. Bei sehr schwacher Batterieladung schaltet sich das Gerät selbstständig ab. Dann den Akku erneut aufladen.

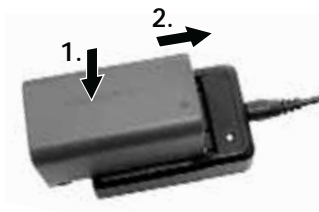

Der Akku darf **nur** mit dem beiliegenden Ladegerät aufgeladen und ausschließlich mit **diesem** Lasergerät verwendet werden. Ansonsten besteht Verletzungs- und Brandgefahr.



Darauf achten, dass sich keine leitenden Gegenstände in die Nähe der Akkukontakte befinden. Ein Kurzschluss dieser Kontakte kann zu Verbrennungen und Feuer führen.



Öffnen Sie den Akku nicht. Es besteht die Gefahr eines Kurzschlusses.

## 2 Stromversorgung

### Lithium-Ionen Akku einlegen

Das Akkufach öffnen und Lithium-Ionen Akku gemäß der Abbildung einlegen.



### Betrieb mit Netz-/Ladegerät

Das Gerät kann mit dem beiliegenden Netz-/Ladegerät betrieben werden.



**!** Der Akku wird während des Netzbetriebes nicht geladen.

## 3 Laserlinien positionieren

Durch den adaptierbaren Metall-Sockel können die Laserlinien genau positioniert werden.



- A** Feststellschraube Gewindestück (11) lösen
- B** 5/8" Gewindestück (5) entnehmen und in das 5/8" -Stativgewinde (4) der Gerätes einschrauben
- C** Das Geräte mit 5/8" Gewindestück auf den Metall-Sockel aufsetzen und der Feststellschraube befestigen

**!** Das Gerät muss zur optimalen Befestigung in der Nut (D) einrasten.

## Justierung mit frei beweglichem Sockel

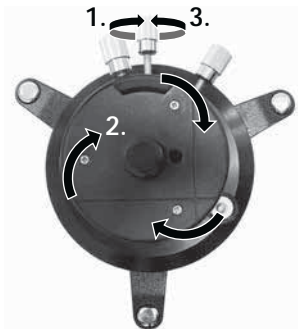

## Justierung mit Seitenfeintrieb

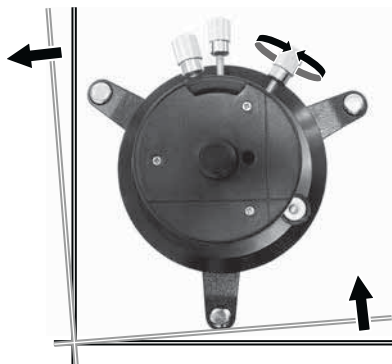

## 4 Horizontales und vertikales Nivellieren

Das Lasergerät anschalten. Jetzt ist die Sensor-Automatik aktiv und nivelliert das Lasergerät automatisch. Sobald die Nivellierung abgeschlossen ist und die auto-LED konstant leuchtet, kann horizontal bzw. vertikal nivelliert werden. Die maximale Genauigkeit wird bei abgeschlossener Nivellierung erzielt.

Die Laser können einzeln mit den Tasten H oder V ein- bzw. ausgeschaltet werden (Tasten kurz drücken).

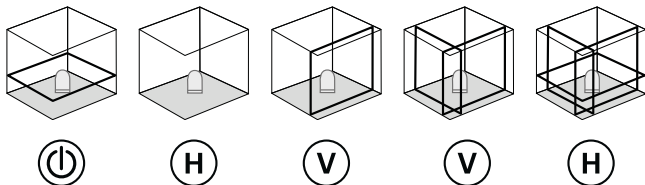

Sobald sich das Gerät außerhalb des automatischen Nivellierbereichs von 2° befindet, blinken die Laserlinien. Positionieren Sie das Gerät so, das es sich innerhalb des Nivellierbereichs befindet.

## 5 Neigungsfunktion, bis max 2°

Mit der Aktivierung der Neigungsfunktion wird die Sensor-Automatic ausgeschaltet. Dazu die Taste 14 (Neigungsfunktion ein) lange drücken, bis die LED Neigungsfunktion (18) schnell blinkt. Jetzt kann die Neigung motorisch eingestellt werden. Zur Neigungseinstellung die H- oder V-Taste permanent drücken. Wenn die Laser blinken, ist der maximale Neigungsbereich erreicht. Mit der Taste 14 (kurz drücken) werden die Achsen umgeschaltet. Die LED Neigungsfunktion (18) blinkt langsam.



Bei der Neigungsfunktion sind die Laserlinien nicht mehr horizontal bzw. vertikal ausgerichtet. Das gilt insbesondere für verstellte Laserlinien. Zum horizontalen bzw. vertikalen Nivellieren die Neigungsfunktion deaktivieren. Dazu das Gerät aus- und wieder anschalten oder die Taste 14 (Neigungsfunktion ein) lange drücken, bis die Laserlinien automatisch verfahren.

## 6 Horizontale Neigung einstellen, bis max 2° (X, Y-Achse)

### Verstellen der X-Achse bis max. 2°

Die LED Neigungsfunktion (18) blinkt schnell.

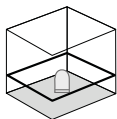

3 Sek.

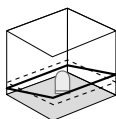
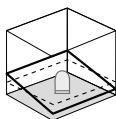

### Verstellen der Y-Achse bis max. 2°

Die LED Neigungsfunktion (18) blinkt langsam.

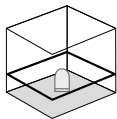

3 Sek.

1 Sek.

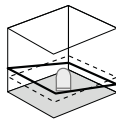
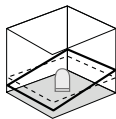



## Verstellen beider Achsen

X-Achse: Die LED Neigungsfunktion (18) blinkt schnell.

Y-Achse: Die LED Neigungsfunktion (18) blinkt langsam.

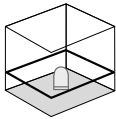

3 Sek.

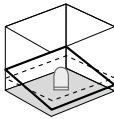

1 Sek.

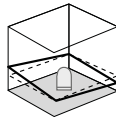

## 7 Vertikale Neigung einstellen, bis max 2° (X, Y-Achse)

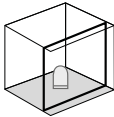
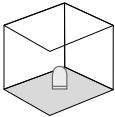
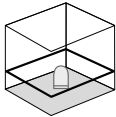

3 Sek.

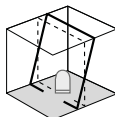
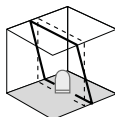

## 8 Neigungsfunktion > 2°

Größere Neigungen können mit der optionalen Winkelplatte, Art-Nr. 080.75 angelegt werden. Dazu ein Kurbelstativ verwenden, z.B. Kurbelstativ P 300 cm, Art-Nr. 080.39. Siehe nachfolgende Abbildungen.

TIPP: Zuerst die Winkelplatte auf Null stellen und das Gerät selbständig ausrichten lassen. Dann die Sensor-Automatic mit der Taste 14 (Neigungsfunktion ein) ausschalten. Anschließend das Gerät in den gewünschten Winkel neigen.

### Neigung einstellen > 2°

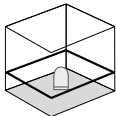

3 Sek.



## 9 Handempfängermodus

### Optional: Arbeiten mit dem Laserempfänger RX

Verwenden Sie zum Nivellieren auf große Entfernungen oder bei nicht mehr sichtbaren Laserlinien einen Laserempfänger RX (optional). Zum Arbeiten mit dem Laserempfänger den Linienlaser durch Drücken der Taste 14 (Handempfängermodus ein / aus) in den Handempfängermodus schalten. Jetzt pulsieren die Laserlinien mit einer hohen Frequenz und die Laserlinien werden dunkler. Der Laserempfänger erkennt durch dieses Pulsieren die Laserlinien.



1 Sek.



**!** Beachten Sie die Bedienungsanleitung des Laserempfängers für Linienlaser.

**!** Aufgrund der speziellen Optik zur Erzeugung einer durchgehenden 360° Laserlinie kann es zu Helligkeitsunterschieden in verschiedenen Bereichen der Linie, kommen, die technisch bedingt sind. Dies kann zu unterschiedlichen Reichweiten im Handempfängermodus führen.

## EU-Bestimmungen und Entsorgung

Das Gerät erfüllt alle erforderlichen Normen für den freien Warenverkehr innerhalb der EU.

Dieses Produkt ist ein Elektrogerät und muss nach der europäischen Richtlinie für Elektro- und Elektronik-Altgeräte getrennt gesammelt und entsorgt werden.

Weitere Sicherheits- und Zusatzhinweise unter:

[www.laserliner.com/info](http://www.laserliner.com/info)

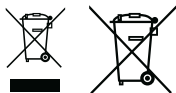

## Kalibrierungsüberprüfung vorbereiten

Sie können die Kalibrierung des Laser kontrollieren. Stellen Sie das Gerät in die **Mitte** zwischen 2 Wänden auf, die mind. 5 m voneinander entfernt sind. Schalten Sie das Gerät ein (**Laserkreuz an**). Zur optimalen Überprüfung bitte ein Stativ verwenden.

1. Markieren Sie Punkt A1 auf der Wand.
2. Drehen Sie das Gerät um 180° u. markieren Sie Punkt A2.  
Zwischen A1 u. A2 haben Sie jetzt eine horizontale Referenz.

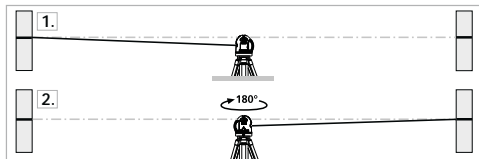

## Kalibrierung überprüfen

3. Stellen Sie das Gerät so nah wie möglich an die Wand auf Höhe des markierten Punktes A1.
4. Drehen Sie das Gerät um 180° und markieren Sie den Punkt A3.  
Die Differenz zwischen A2 u. A3 ist die Toleranz.

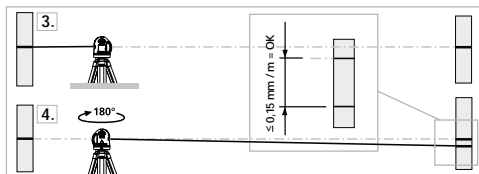

**!** Wenn A2 und A3 mehr als 0,15 mm / m auseinander liegen, ist eine Kalibrierung erforderlich. Setzen Sie sich mit Ihrem Fachhändler in Verbindung oder wenden Sie sich an die Serviceabteilung von UMAREX-LASERLINER.

## Überprüfung der vertikalen Linie

Gerät ca. 5 m vor einer Wand aufstellen. An der Wand ein Lot mit einer 2,5 m langen Schnur befestigen, das Lot sollte dabei frei pendeln. Gerät einschalten und den vertikalen Laser auf die Lotschnur richten. Die Genauigkeit liegt innerhalb der Toleranz, wenn die Abweichung zwischen Laserlinie und Lotschnur nicht größer als  $\pm 0,75$  mm beträgt.

## Überprüfung der horizontalen Linie

Gerät ca. 5 m vor einer Wand aufstellen und Laserkreuz einschalten. Punkt B an der Wand markieren. Laserkreuz ca. 2,5 m nach rechts schwenken und Punkt C markieren. Überprüfen Sie, ob waagerechte Linie von Punkt C  $\pm 0,75$  mm auf der gleichen Höhe mit dem Punkt B liegt. Vorgang durch Schwenken nach links wiederholen.

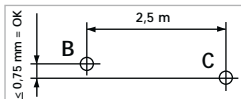

**!** Überprüfen Sie regelmäßig die Kalibrierung vor dem Gebrauch, nach Transporten und langer Lagerung.

## Technische Daten (Technische Änderungen vorbehalten. 02.17)

Selbstnivellierbereich	$\pm 2^\circ$
Genauigkeit	$\pm 0,15 \text{ mm / m}$
Arbeitsbereich (von Raumhelligkeit abhängig)	20 m
Arbeitsbereich mit Handempfänger (von technisch bedingtem Helligkeitsunterschied abhängig)	30 m
Laserwellenlänge Linienlaser	635 nm
Laserklasse	2 / < 1 mW
Stromversorgung	Li-Ionen Akkupack 7,4 V / 2600 mA Netzteilbetrieb
Betriebsdauer mit 3 Laserebenen mit 2 Laserebenen mit 1 Laserebene	ca. 7 Std. ca. 10 Std. ca. 15 Std.
Arbeitstemperatur	0°C ... +50°C
Lagertemperatur	-10°C ... +70°C
Abmessungen (B x H x T)	180 x 145 x 125 mm
Gewicht (inkl. Akkupack)	1,51 kg



Read the operating instructions and the enclosed brochure „Guarantee and additional notices“ completely. Follow the instructions they contain. This document must be kept in a safe place and if the laser device is passed on, this document must be passed on with it.

## Function / Application

Three-dimensional laser with three red 360° laser circles and adaptable metal base

- Additional slope function for aligning inclines
- Motorised adjustment up to  $\pm 2^\circ$
- Out-Of-Level: is indicated by optical signals when the unit is outside its self-levelling range.
- Adaptable metal base for exact laser line positioning with the rotary casing with vernier adjustment mechanism.
- Automatic levelling range  $2^\circ$ , accuracy 0.15 mm / m

## General safety instructions

- The device must only be used in accordance with its intended purpose and within the scope of the specifications.



Laser radiation!  
Do not stare into the beam!  
Class 2 laser  
< 1 mW · 635 nm  
EN 60825-1:2014

- Attention: Do not look into the direct or reflected beam.
- Do not point the laser beam towards persons.
- If a person's eyes are exposed to class 2 laser radiation, they should shut their eyes and immediately move away from the beam.
- Under no circumstances should optical instruments (magnifying glass, microscope, binoculars) be used to look at the laser beam or reflections.
- Do not use the laser at eye level (1.40 ... 1.90 m)
- Reflective, specular or shiny surfaces must be covered whilst laser devices are in operation.

- In public areas shield off the laser beam with barriers and partitions wherever possible and identify the laser area with warning signs.
- Tampering with (making changes to) the laser device is not permitted.
- This device is not a toy - keep out of the reach of children.

## Special product features



Electronic vials and positioning motors controlled by temperature-stable sensors for automatic alignment of devices. The device is brought into initial position and aligns itself autonomously.



This function is automatically enabled when the sensor automatic is switched on. This easily enables the horizontal or vertical levelling at a required height, for instance in connection with a crank tripod or wall mount. Also, the laser can be used on vibrating surfaces and in windy conditions.



Transport LOCK: The device is protected by a special motor brake during transport.



Special high performance laser diodes generate even brighter laser lines as units with PowerBright Technology do. They remain visible over longer distances, in bright ambient lighting conditions and on dark surfaces.



RX-READY technology enables line lasers to be used even in unfavourable light conditions. The laser lines pulsate at a high frequency and this can be picked up by special laser receivers over long distances.

## Number and direction of the lasers

H = horizontal laser

V = vertical laser

S = slopefunction

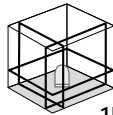

1H360° 2V360°



S

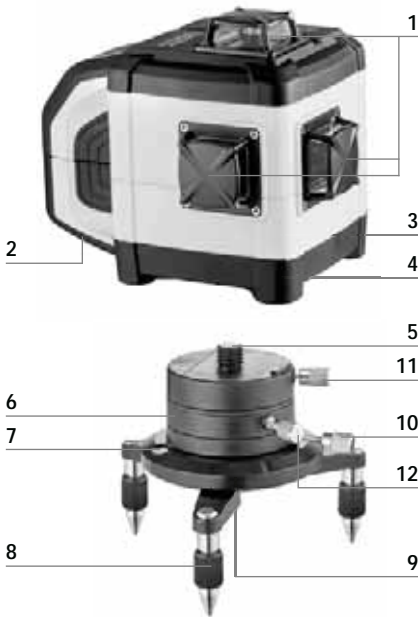

- 1 Laser output windows
- 2 Rechargeable battery compartment (bottom)
- 3 Connecting socket for mains adapter (12V/2000mA, no charging function)
- 4 5/8" tripod thread (bottom)
- 5 5/8" threaded adapter
- 6 Free-moving base
- 7 Circular bubble level
- 8 Adjustable feet
- 9 5/8" tripod thread
- 10 Lock
- 11 Threaded adapter lock screw
- 12 Vernier adjustment mechanism

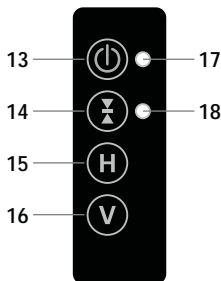

- 13 ON/OFF button
- 14 Hand receiver mode on / off / slope function ON
- 15 Horizontal laser lines
- 16 Vertical laser lines
- 17 LED status indicator / automatic mode (LED blinks during set-up phase)
- 18 LED hand receiver mode / Slope function LED

## 1 Use of lithium-ion rechargeable battery

Fully charge the battery before using for the first time. To charge the battery, place it in the supplied battery charger. Ensure the battery is inserted the right way round. When the rechargeable battery is being charged, the LED on the charger lights up red. When the LED changes to green, charging is complete. LEDs (17) and (18) flashing indicates that the battery charge level is low. The device switches off automatically when the battery charge is very low. In that case, recharge the battery.

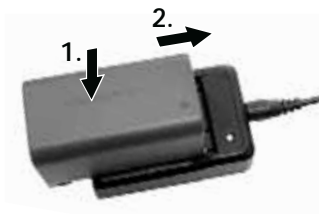

The battery may **only** be charged with the battery charger provided and used only in **this** laser device. Any other use may cause injury or fire.



Make sure there are no conductive objects in the vicinity of the battery contacts. Short-circuiting of these contacts can cause burn injuries or fire.



Do not open the rechargeable battery. This could cause short-circuits.



## 2 Power supply

### To insert the lithium-ion rechargeable battery

Open the battery compartment and insert the lithium-ion battery as illustrated.



### Operation with power pack/battery charger

The device can be used with the supplied power pack/battery charger.



**!** The battery is not charged when connected to the power supply.

## 3 Positioning laser lines

The adaptable metal base allows precise positioning of the laser lines.



- A** Undo threaded adapter lock screw (11)
- B** Remove 5/8" threaded adapter (5) and screw the device into the 5/8" thread (4) in the stand.
- C** Place the device with 5/8" threaded adapter on the metal base and tighten the lock screw

**!** To secure the device correctly it must snap into the groove (D).

### Alignment with free-moving base

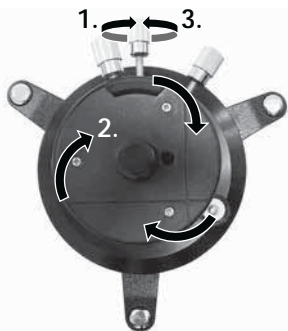

### Alignment with vernier adjustment

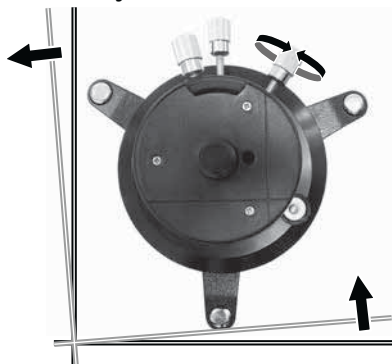

## 4 Horizontal and vertical levelling

Switch the laser device on. The automatic sensor is now active and will level the laser device automatically. As soon as device-levelling is completed and the auto LED illuminates continuously, horizontal or vertical object levelling can be carried out. Maximum accuracy is attained when device-levelling is completed.

Lasers can be switched on and off individually with the H or V buttons (press buttons briefly).

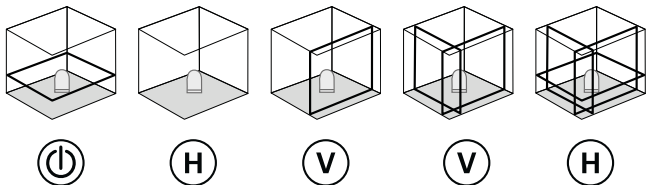

**!** The laser lines flash when the device is outside the automatic levelling range of 2°. Position the device such that it is within the levelling range.

## 5 Slope function up to max. 2°

Activation of the slope function deactivates the automatic sensor. Press and hold button 14 (slope function ON) until the slope function LED (18) flashes rapidly. Motordriven adjustment of the slope can now be carried out. Press and hold the H or V button to adjust slope. When the lasers blink, the maximum slope range has been reached. Button 14 (pressed briefly) switches between axes. The slope function LED (18) flashes slowly.



For the slope function, laser lines are no longer aligned to the horizontal or vertical plane. This is a specific peculiarity of adjusted laser lines. To reinstate horizontal or vertical levelling, deactivate the slope function. To do so, switch the device off and back on or keep button 14 (slope function ON) pressed until the laser lines move automatically.

## 6 Horizontal levelling adjustment up to a max. of 2° (X, Y axis)

### Adjustment of the X axis up to a max. of 2°

The slope function LED (18) flashes rapidly.

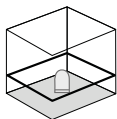

3 sec.

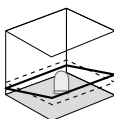
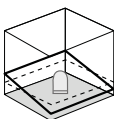

### Adjustment of the Y axis up to a max. of 2°

The slope function LED (18) flashes slowly.

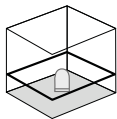

3 sec.

1 sec.

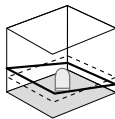
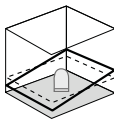

### Adjusting both axes

X axis: The slope function LED (18) flashes rapidly.

Y axis: The slope function LED (18) flashes slowly.

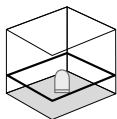

3 sec.

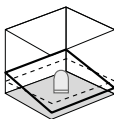

1 sec.

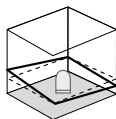

### 7 Adjust vertical slope, to a max. of 2° (X, Y axis)

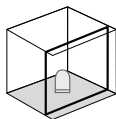
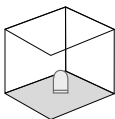
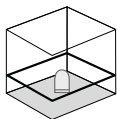

3 sec.

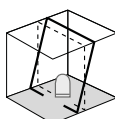
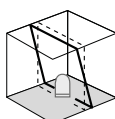

### 8 Slope function > 2°

Steeper slopes can be set using the angle plate, which is available as an optional extra (product ref. 080.75). To this end you need to use a crank tripod, such as the 300 cm crank tripod P 300 cm, product ref. 080.39. Refer to the illustrations below.

TIP: Set the angle plate to the zero position and allow the device to align itself automatically. Then switch off the automatic sensor with button 14 (slope function ON). Finally, incline the device to the angle you require.

### Slope adjustment > 2°

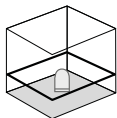

3 sec.



## 9 Hand receiver mode

### Optional: Working with the laser receiver RX

Use an RX laser receiver (optional) to carry out levelling at great distances or when the laser lines are no longer visible. To work with a laser receiver, switch the line laser to hand-held receiver mode by keeping button 14 (hand-held receiver mode on / off) pressed. The laser lines will now pulsate with high frequency, making the laser lines darker. The laser receiver can detect these pulsating laser lines.



**!** Observe the laser receiver's operating instructions for line lasers.

**!** Due to the special optics required to generate a continuous 360° laser line, the underlying technology may cause differences in brightness in different areas of the line. This may lead to different ranges in hand receiver mode.

## EU directives and disposal

This device complies with all necessary standards for the free movement of goods within the EU.

This product is an electric device and must be collected separately for disposal according to the European Directive on waste electrical and electronic equipment.

Further safety and supplementary notices at:  
[www.laserliner.com/info](http://www.laserliner.com/info)

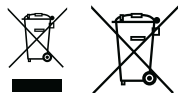

## Preparing the calibration check

It is possible for you to check the calibration of the laser. To do this, position the device **midway** between 2 walls, which must be at least 5 metres apart. Switch the device on (**Laser cross ON**). The best calibration results are achieved if the device is mounted on a tripod.

1. Mark point A1 on the wall.
2. Turn the device through 180° and mark point A2. You now have a horizontal reference between points A1 and A2.

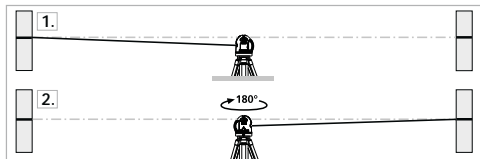

## Performing the calibration check

3. Position the device as near as possible to the wall at the height of point A1.
4. Turn the device through 180° and mark point A3. The difference between points A2 and A3 is the tolerance.

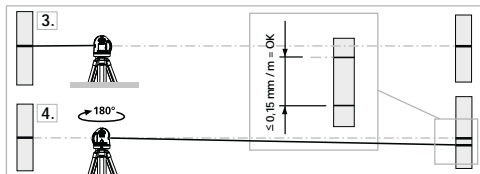

**!** If points A2 and A3 are more than 0.15 mm / m, the device is in need of calibration. Contact your authorised dealer or else the UMAREX-LASERLINER Service Department.

## Checking the vertical line

Position the device about 5 m from a wall. Fix a plumb bob with a line of 2.5 m length on the wall, making sure that the bob can swing freely. Switch on the device and align the vertical laser to the plumb line. The precision is within the specified tolerance if the deviation between the laser line and the plumb line is not greater than  $\pm 0.75$  mm.

## Checking the horizontal line

Position the device about 5 m from a wall and switch on the cross laser. Mark point B on the wall. Turn the laser cross approx. 2.5 m to the right and mark point C. Check whether the horizontal line from point C is level with point B to within  $\pm 0.75$  mm. Repeat the process by turning the laser to the left.

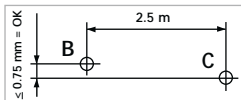

**!** Regularly check the calibration before use, after transport and after extended periods of storage.

## Technical data (Subject to technical changes without notice. 02.17)

Self-levelling range	$\pm 2^\circ$
Accuracy	$\pm 0.15$ mm / m
Operating range (depending on room illumination)	20 m
Working range with hand receiver depends on how the technology affects the difference in brightness)	30 m
Laser wavelength linelaser	635 nm
Laser class	2 / < 1 mW
Power supply	Li-Ion rechargeable battery pack 7.4 V / 2600 mA Power pack operation
Operating time with 3 laser levels with 2 laser levels with 1 laser level	approx. 7 hours approx. 10 hours approx. 15 hours
Operating temperature	0°C ... +50°C
Storage temperature	-10°C ... +70°C
Dimensions (W x H x D)	180 x 145 x 125 mm
Weight (including battery pack)	1.51 kg



Lees de bedieningshandleiding en de bijgevoegde brochure 'Garantie- en aanvullende aanwijzingen' volledig door. Volg de daarin beschreven aanwijzingen op. Bewaar deze documentatie en geef ze door als u de laserinrichting doorgeeft.

## Functie / Toepassing

Driedimensionale laser met drie rode 360°-lasercirkels en aanpasbare metaalsokkel

- Extra neigingsfunctie voor de uitlijning van schuine vlakken
- motorische verstelling van  $\pm 2^\circ$  mogelijk
- Out-Off-Level: door optische signalen wordt gesignaleerd, wanneer het apparaat zich buiten het nivelleerbereik bevindt.
- Aanpasbare metaalsokkel voor de exacte positionering van de laserlijnen dankzij de draaibare fijne zijaandrijving.
- Zelfnivelleringsbereik  $2^\circ$ , nauwkeurigheid 0,15 mm / m

## Algemene veiligheidsaanwijzingen

- Gebruik het apparaat uitsluitend doelmatig binnen de aangegeven specificaties.



Laserstraling!  
Niet in de straal kijken!  
Laser klasse 2  
< 1 mW · 635 nm  
EN 60825-1:2014

- Opgelet: Kijk nooit in de directe of reflecterende straal.
- Richt de laserstraal niet op personen.
- Als laserstraling volgens klasse 2 de ogen raakt, dient u deze bewust te sluiten en uw hoofd zo snel mogelijk uit de straal te bewegen.
- Bekijk de laserstraal of de reflecties nooit met behulp van optische apparaten (loep, microscoop, verrekijker, ...).
- Gebruik de laser niet op ooghoogte (1,40 ... 1,90 m).
- Goed reflecterende, spiegelende of glanzende oppervlakken moeten tijdens het gebruik van laserinrichtingen worden afgedekt.



- In openbare verkeersbereiken moet de lichtbaan zo goed mogelijk door afbakeningen en scheidingswanden beperkt en het laserbereik door middel van waarschuwingsborden gekenmerkt worden.
- Manipulaties (wijzigingen) aan de laserinrichting zijn niet toegestaan.
- Dit apparaat is geen speelgoed en hoort niet thuis in kinderhanden.

## Bijzondere producteigenschappen



Automatische uitlijning van de apparaten dankzij elektronische libellen en servomotoren met temperatuurvaste sensoriek. Het apparaat wordt in de uitgangspositie gebracht en lijnt zelfstandig uit.



Deze functie is automatisch actief als u de sensor-automatic aanzet. Hiermee wordt het horizontaal en verticaal nivelleren eenvoudiger. De laserstraal valt niet uit als u de laser met behulp van statief of wandhouder op de goede hoogte plaatst, of bij beweeglijke ondergronden en wind.



Transport LOCK: Het apparaat wordt tijdens het transport beschermd met een speciale motorrem.



Speciale hoogvermogensdioden produceren nog fellere laserlijnen als de lasers met PowerBright technologie. Deze blijven zichtbaar over langere afstand, bij fel omgevingslicht en op donkere oppervlakken.



Met de RX-READY-technologie kunnen lijnlasers ook bij ongunstige lichtomstandigheden worden gebruikt. De laserlijnen pulseren dan met een hoge frequentie en worden door speciale laserontvangers op grote afstanden geregistreerd.

## Aantal en richting van de laser

H = horizontale laserlijn

V = verticale laserlijn

S = inclinaties (Slope-functie)

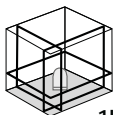

1H360° 2V360°



S



- 1 Laseruitlaat
- 2 Laseruitlaat (onderzijde)
- 3 Aansluitbus voor netadapter (12 V / 2000 mA, geen laadfunctie)
- 4 5/8" -schroefdraad voor statief (onderzijde)
- 5 5/8" -schroefdraadstuk
- 6 Vrij beweeglijke sokkel
- 7 Dooswaterpas
- 8 Afstelvoetjes
- 9 5/8" -schroefdraad voor statief
- 10 Vergrendeling
- 11 Vastzetschroef schroefdraadstuk
- 12 Fijnafstelling opzij

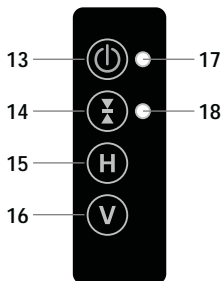

- 13 AAN-/UIT-toets
- 14 Handontvangermodus aan / uit / neigingsfunctie aan
- 15 Horizontale laserlijnen
- 16 Verticale laserlijnen
- 17 LED-bedrijfsindicator / automatisch bedrijf (LED knippert tijdens de inrichtfase)
- 18 LED Handontvangermodus / LED voor de neigingsfunctie

## 1 Gebruik van de lithium-ionen-accu

Laad de accu vóór het eerste gebruik volledig op. Plaats daarvoor de accu in het bijgeleverde laadtoestel. Let daarbij op dat u de accu correct inschuift. Terwijl de accu gealden wordt, brandt de LED van het laadtoestel rood. Het laadproces is afgesloten wanneer de LED groen brandt. Als de leds (17) en (18) knipperen, is de batterijlading zwak. Bij een zeer zwakke batterijlading schakelt het apparaat zelfstandig uit. In dat geval moet de accu opnieuw worden op-geladen.

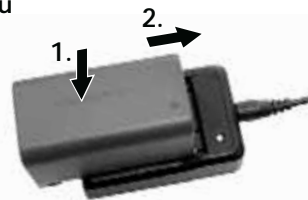

! De accu mag **alleen** worden opgeladen met het bijgeleverde laadtoestel en mag uitsluitend met **dit** laserapparaat worden gebruikt. In het andere geval bestaat gevaar voor letsel en brand.

! Let op dat zich in de buurt van de accucontacten geen geleidende voorwerpen bevinden. Een kortsluiting van deze contacten kan leiden tot brand en verbrandingen.

! Open de accu nooit. Er bestaat gevaar voor kortsluiting.

## 2 Stroomvoorzorging

### Lithium-ion-accu plaatsen

Open het accuvak en plaats de lithium-ion-accu zoals op de afbeelding.



### Gebruik met netadapter/laadtoestel

Het apparaat kan worden gebruikt met de/het bijgeleverde netadapter/laadtoestel.



**!** De accu wordt niet opgeladen tijdens het gebruik op netvoeding.

## 3 Laserlijnen positioneren

Met behulp van de aanpasbare metaalsokkel kunnen de laserlijnen exact worden gepositioneerd.

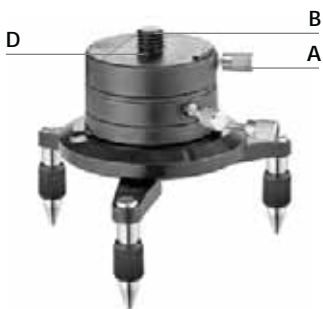

- A Vastzetschroef schroefdraadstuk (11) losdraaien
- B 5/8"-schroefdraadstuk (5) verwijderen en in de 5/8"-schroefdraad voor het statief (4) van het apparaat schroeven
- C De apparaten met 5/8" -schroefdraadstuk op de metaalsokkel plaatsen en de vastzetschroef bevestigen

**!** Voor de optimale bevestiging moet het apparaat in de groef (D) vastklikken.

## Afstelling met vrij beweeglijke sokkel

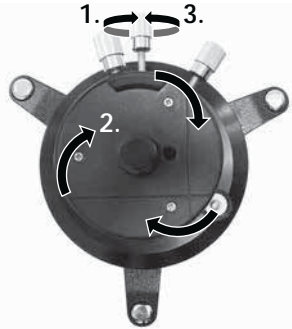

## Afstelling met fijnafstelling opzij

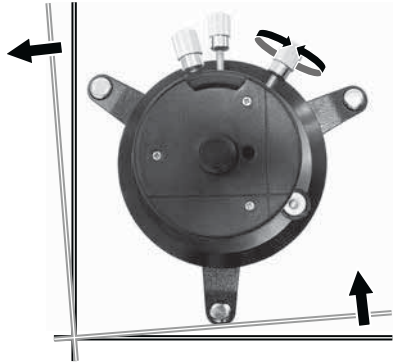

## 4 Horizontaal en verticaal nivelleren

Schakel het laserapparaat in. Nu is de Sensor-Automatic actief en nivelleert het laserapparaat automatisch. Zodra de nivellering is voltooid en de auto-LED constant brandt, kan horizontaal resp. verticaal worden genivelleerd. De maximale nauwkeurigheid wordt bij voltooide nivellering bereikt.

De lasers kunnen afzonderlijk in- of uitgeschakeld worden met de toetsen H of V (toetsen kort indrukken).

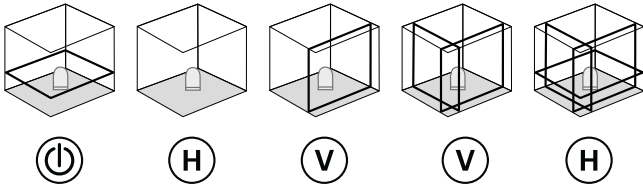

Zodra het apparaat zich buiten het automatische nivelleerbereik van 2° bevindt, knippen de laserlijnen. Positioneer het apparaat zodanig dat het zich binnen het nivelleerbereik bevindt.

## 5 Neigingsfunctie, tot max. 2°

Met de activering van de neigingsfunctie schakelt u de Sensor-Automatic uit. Druk daarvoor lang op toets 14 (neigingsfunctie aan) totdat de led voor de neigingsfunctie (18) snel knippert. Nu kan de neiging motorisch worden ingesteld. Druk constant op de H- of V-toets om de neiging in te stellen. Als de lasers knipperen, is het maximale neigingsbereik bereikt. Met toets 14 (kort indrukken) worden de assen omgeschakeld. De led voor de neigingsfunctie (18) knippert langzaam.



Bij de neigingsfunctie zijn de laserlijnen niet meer horizontaal resp. verticaal uitgelijnd. Dit geldt vooral voor verstelde laserlijnen. Deactiveer de neigingsfunctie voor de horizontale resp. verticale nivellering. Schakel daarvoor het apparaat uit en weer in of houd toets 14 (neigingsfunctie aan) ingedrukt totdat de laserlijnen automatisch bewegen.

## 6 Horizontale neiging instellen, tot max. 2° (X-, Y-as)

### Verstelling van de X-as tot max. 2°

De led voor de neigingsfunctie (18) knippert snel.

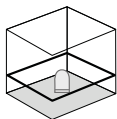

3 sec.

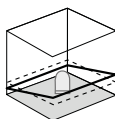
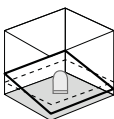

### Verstelling van de Y-as tot max. 2°

De led voor de neigingsfunctie (18) knippert langzaam.

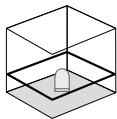

3 sec.

1 sec.

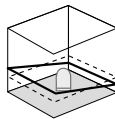
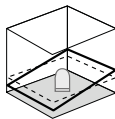

## Verstellen van beide assen

X-as: De led voor de neigingsfunctie (18) knippert snel.

Y-as: De led voor de neigingsfunctie (18) knippert langzaam.

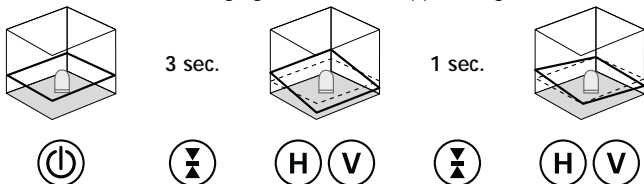

## 7 Verticale neiging instellen, tot max. 2° (X, Y-as)

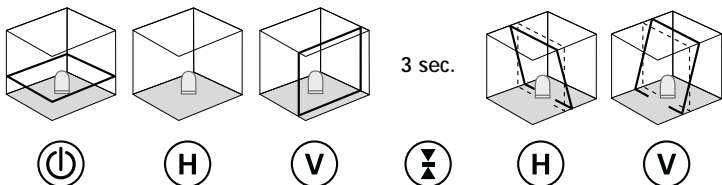

## 8 Neigingsfunctie > 2°

Grotere neigingen kunnen met de optionele hoekplaat, art.-nr. 080.75 worden aangelegd. Gebruik daarvoor een krukstatief, bijv. krukstatief P 300 cm, art.nr. 080.39. Zie ook de navolgende afbeeldingen.

TIP: zet de hoekplaat eerst op nul en laat het apparaat zelfstandig uitlijnen. Schakel vervolgens de 'Sensor-Automatic' uit met toets 14 (neigingsfunctie aan). Neig het toestel vervolgens in de gewenste hoek.

## Neiging instellen > 2°

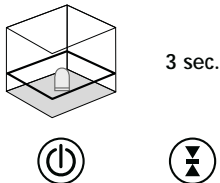

## 9 Handontvangermodus

### Optioneel: Werken met de laserontvanger RX

Gebruik een laserontvanger RX (optioneel) voor het nivelleren op grote afstanden of in geval van niet meer zichtbare laserlijnen. Schakel de lijnlaser voor werkzaamheden met de laser-ontvanger in de handontvangermodus door op de toets 14 te drukken. Nu pulseren de laserlijnen met een hoge frequentie en de laserlijnen worden donkerder. De laserontvanger kan de laserlijnen dankzij het pulseren registreren.

  
1 sec.



**!** Neem de gebruiksaanwijzing van de laserontvanger voor lijnlasers in acht.

**!** Op grond van de speciale optiek voor de generering van een ononderbroken 360° laserlijn kunnen om technische redenen helderheidsverschillen optreden in de verschillende bereiken van de lijn. Dit kan leiden tot verschillende reikwijdten in de handontvangermodus.

## EU-bepalingen en afvoer

Het apparaat voldoet aan alle van toepassing zijnde normen voor het vrije goederenverkeer binnen de EU.

Dit product is een elektrisch apparaat en moet volgens de Europese richtlijn voor oude elektrische en elektronische apparatuur gescheiden verzameld en afgevoerd worden.

Verdere veiligheids- en aanvullende instructies onder:  
[www.laserliner.com/info](http://www.laserliner.com/info)

**CE**

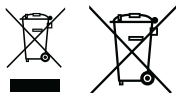



## Kalibratiecontrole voorbereiden

U kunt de kalibratie van de laser controleren. Plaats het toestel in het **midden** tussen twee muren die minstens 5 meter van elkaar verwijderd zijn (**laserkruis aan**). Voor een optimale controle een statief gebruiken.

1. Markeer punt A1 op de wand.
2. Draai het toestel 180° om en markeer het punt A2.  
Tussen A1 en A2 hebt u nu een horizontale referentie.

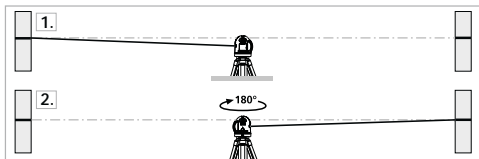

## Kalibratie controleren

3. Plaats het toestel zo dicht mogelijk tegen de wand ter hoogte van punt A1.
4. Draai het toestel vervolgens 180° en markeer punt A3. Het verschil tussen A2 en A3 moet binnen de tolerantie van de nauwkeurigheid liggen.

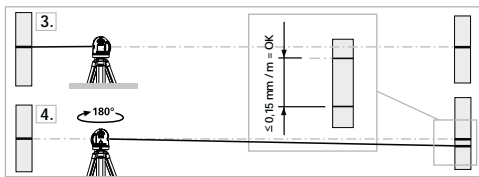

**!** Wanneer het verschil tussen punt A2 en A3 groter is dan de aangegeven tolerantie, nl. 0,15 mm / m, is een kalibratie nodig. Neem hiervoor contact op met uw vakhandelaar of met de serviceafdeling van UMAREX-LASERLINER.

### Controleren van de verticale lijn

Apparaat op ca. 5 meter van de wand opstellen, aan de wand een lood met ongeveer 2 meter draad bevestigen, de draad moet vrij kunnen pendelen, apparaat instellen in de verticale positie en wanneer u de draad nadert, mag het verschil niet meer zijn dan  $\pm 0,75$  mm. In dat geval blijft u binnen de gestelde tolerantie.

### Controleren van de horizontale lijn

Apparaat op ca. 5 meter van de wand opstellen, en het laserkruis instellen, punt B aan de wand markeren, laserkruis ca. 2,5 meter naar rechts draaien en punt C markeren. Controleer nu of de waterpaslijn van punt C op gelijke hoogte ligt met punt B - met een tolerantie van max.  $\pm 0,75$  mm. Dezelfde controle kunt u tevens naar links uitvoeren.

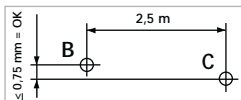

**!** Controleer regelmatig de kalibratie voordat u de laser gebruikt, ook na transport en wanneer de laser langere tijd is opgeborgen geweest.

### Technische gegevens (Technische veranderingen voorbehouden. 02.17)

Zelfnivelleerbereik	$\pm 2^\circ$
Nauwkeurigheid	$\pm 0,15$ mm / m
Werkbereik (afhankelijk van de hoeveelheid licht)	20 m
Werkbereik met handontvanger (afhankelijk van de helderheidsverschillen om technische redenen)	30 m
Lasergolflengte lijnlaser	635 nm
Laserklasse	2 / < 1 mW
Stroomvoorziening	Li-ion accupak 7,4 V / 2600 mA Netadaptervoeding
Gebruiksduur met 3 laserniveaus met 2 laserniveaus met 1 laserniveau	ca. 7 uur ca. 10 uur ca. 15 uur
Werktemperatuur	0°C ... +50°C
Opbergtemperatuur	-10°C ... +70°C
Afmetingen (B x H x D)	180 x 145 x 125 mm
Gewicht (incl. accupak)	1,51 kg

**!** Læs betjeningsvejledningen og det vedlagte hæfte „Garanti-oplysninger og supplerende anvisninger“ grundigt igennem. Følg de heri indeholdte instrukser. Dette dokument skal opbevares og følge med laserenheden, hvis denne overdrages til en ny bruger.

## Funktion / Anvendelsesformål

- Tredimensional laser med tre røde 360°-lasercircles og adapterbar metalsokkel
- Ekstra hældningsfunktion til indjustering af skrå flader
- Mulighed for motorindstilling på  $\pm 2^\circ$
- Out-Off-Level: Det indikeres via optiske signaler, når apparatet er uden for nivelleringsområdet.
- Tilpasbar metalsokkel til nøjagtig positionering af laserlinjerne ved hjælp af det drejelige hus med sidefinjustering.
- Selvnivelleringsområde  $2^\circ$ , nøjagtighed 0,15 mm / m

## Almindelige sikkerhedshenvisninger

- Apparatet må kun bruges til det tiltænkte anvendelsesformål inden for de givne specifikationer.



Laserstråling!  
Se ikke ind i strålen!  
Laser klasse 2  
< 1 mW · 635 nm  
EN 60825-1:2014

- Pas på: Undgå at se ind i en direkte eller reflekterende stråle.
- Undgå at rette laserstrålen mod personer.
- Hvis laserstråling i klasse 2 rammer en person i øjnene, skal vedkommende bevidst lukke øjnene og straks fjerne hovedet fra strålen.
- Laserstrålen eller dens refleksioner må aldrig betragtes gennem optisk udstyr (lup, mikroskop, kikkert, ...).
- Undlad at anvende laseren i øjenhøjde (1,40 ... 1,90 m).
- Godt reflekterende, spejlende eller skinnende overflader skal tildækkes, så længe der bruges laserudstyr.

- I områder med offentlig færdsel skal strålebanen så vidt muligt begrænses af afspærringer og skillevægge, og laserområdet skal afmærkes med advarselsskilte.
- Manipulation (ændring) af laserenheden er ikke tilladt.
- Denne enhed er ikke legetøj og hører ikke hjemme i hænderne på børn.

## Særlige produktgenskaber



Automatisk indstilling af apparaterne ved hjælp af elektroniske libeller og servomotorer med temperaturstabil sensorteknologi. Apparatet nulstilles og indstiller sig automatisk.



Denne funktion er automatisk aktiv, når Sensor-Automatic er slået til. Dette letter horisontal eller vertikal nivellering fx til indstilling af laseren i en ønsket højde med et stativ med håndsving eller en vægholder. Desuden kan apparatet nivelleres på vibrerende underlag og i blæsevej.



Transport LOCK (LÅS): Under transport beskyttes apparatet af en særlig motorbremse.



Specielle, kraftige dioder frembringer endnu skarpere laserlinjer end apparater med PowerBright-teknologi. Disse kan også ses på længere afstand, i skarpt omgivelseslys samt på mørke overflader.



Med RX-READY-teknologien kan linielasere anvendes selv under ugunstige lysforhold. Laserlinjerne pulserer da med høj frekvens og kan derved findes med sensor.

## Antal og placering af lasere

H = horisontal laserlinje  
V = vertikal laserlinje  
S = hældningsfunktion

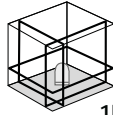

1H360° 2V360°



S

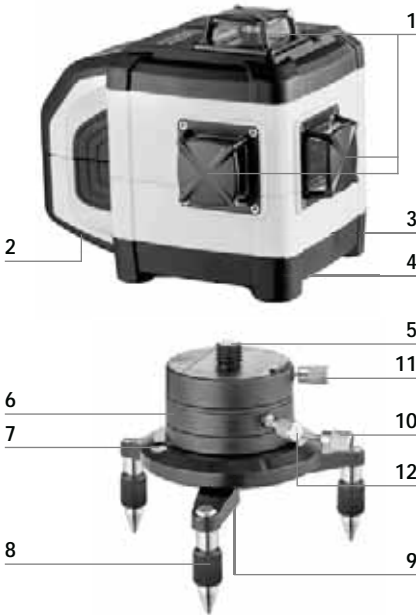

- 1 Lasers udgangsrude
- 2 Batterirum (underside)
- 3 Tilslutningsstik til lysnetadapter (12V/2000mA, uden ladefunktion)
- 4 5/8" -schroefdraad voor statief (underside)
- 5 5/8" -schroefdraadstuk
- 6 Vrij beweeglijke sokkel
- 7 Dooswaterpas
- 8 Afstelvoetjes
- 9 5/8" -schroefdraad voor statief
- 10 Vergrendeling
- 11 Vastzetschroef schroefdraadstuk
- 12 Fijnafstelling opzij

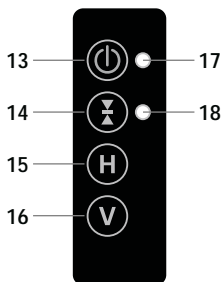

- 13 TIL-/FRA-knap
- 14 Håndmodtagermodus til / fra / Hældningsfunktion TIL
- 15 Horisontale laserlinjer
- 16 Vertikale laserlinjer
- 17 LED driftsindikator / automatisk drift (LED blinker i indjusteringsfasen)
- 18 LED Håndmodtagermodus / LED hældningsfunktion

## 1 Håndtering af genopladeligt lithium-ion-batteri

Inden første ibrugtagning skal batteriet lades helt op. Dette gøres ved at sætte batteriet i den medfølgende oplader. Vær opmærksom på korrekt indskubningsretning. Mens det genopladelige batteri oplades, lyser LED'en på opladeren rødt. Ladeprocessen er afsluttet når LED'en lyser grønt. Så snart LED'erne (17) og (18) blinker, betyder det, at batteriladningen er svag. Når batteriladningen er meget svag, slukker apparatet automatisk. Batteriet skal da genoplades.

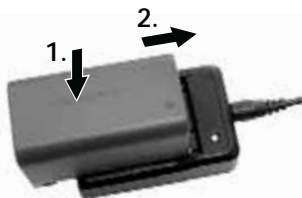

! Det genopladelige batteri **må kun** oplades med den medfølgende oplader og må kun bruges i forbindelse med **dette** laserapparat. Ellers er der fare for personskade og brand.

! Sørg for, at der ikke er ledende genstande i nærheden af batterikontakterne. Kortslutning af disse kontakter kan medføre forbrænding og brand.

! Undlad at åbne det genopladelige batteri. Fare for kortslutning.

## 2 Strømforsyning

### Isætning af lithium-ion-batteriet

Åbn batterirummet, og isæt lithium-ion-batteriet som vist på figuren.



### Anvendelse med lysnetadapter/oplader

Apparatet kan anvendes med de medfølgende lysnetadapter/oplader.



**!** Batteriet oplades ikke, mens man benytter lysnetadapteren.

## 3 Indstilling af laserlinjerne

Via den tilpasbare metalsokkel kan laserlinjerne positioneres præcist.



- A** Fastspændingsskrue gevindstykke (11) løsnes
- B** 5/8" - gevindstykket (5) tages af og skrues ind i apparatets 5/8" - stativgevind (4)
- C** Apparatet med 5/8" - gevindstykke sættes på metalsoklen, og fastspændingsskruen spændes til

**!** For optimal fastgørelse skal apparatet gå i indgreb i rillen (D).

### Justering med frit bevægelig sokkel

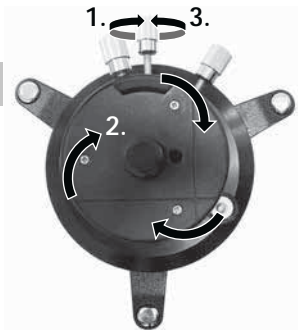

### Justering med sidefinindstilling

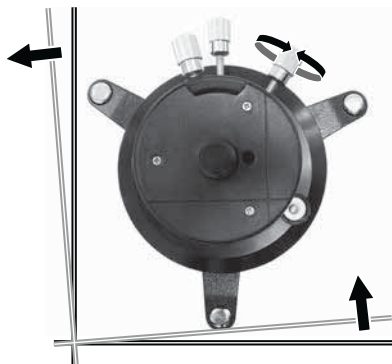

## 4 Horisontal og vertikal nivellering

Tænd laserapparatet. Nu er sensorautomatikken aktiv og nivellerer automatisk laserapparatet. Så snart nivelleringen er udført, og auto-LED'en lyser konstant, kan man foretage horisontal eller vertikal nivellering. Den maksimale nøjagtighed opnås, når nivelleringen er afsluttet.

Laserne kan tændes eller slukkes enkeltvis med knapperne H eller V (tryk kortvarigt på knappen).

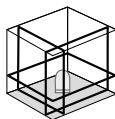
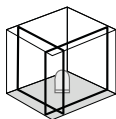
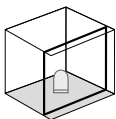
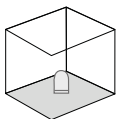
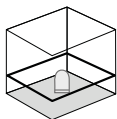

Så snart apparatet er uden for det automatiske nivelleringsområde på 2°, blinker laserlinjerne. Apparatet skal positioneres således, at det er inden for nivelleringsområdet.



## 5 Hældningsfunktion, op til max 2°

Når hældningsfunktionen aktiveres, slukkes der samtidigt for Sensor-Automatic-funktionen. Dette gøres ved at holde knappen 14 (hældningsfunktion TIL) inde, indtil LED'en hældningsfunktion (18) blinker hurtigt. Nu kan hældningen indstilles motorisk. Man foretager hældningsindstillingen ved at holde H- eller V-knappen inde konstant. Når laserne blinker, er det maksimale hældningsområde nået. Med knappen 14 (trykkes kortvarigt ind) omskiftes akserne. LED'en hældningsfunktion (18) blinker langsomt.



Ved hældningsfunktionen er laserlinjerne ikke længere indstillet horisontalt eller vertikalt. Dette gælder især for justerede laserlinjer. Til horisontal eller vertikal nivellering skal man deaktivere hældningsfunktionen. Dette gøres ved at slukke og tænde for apparatet eller ved at holde knappen 14 (hældningsfunktion TIL) inde, indtil laserlinjerne bevæger sig automatisk.

## 6 Indstilling af horisontal hældning, op til max 2° (X-, Y-akse)

### Justering af X-aksen op til max 2°

LED'en hældningsfunktion (18) blinker hurtigt.

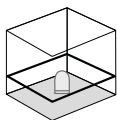

3 sek.

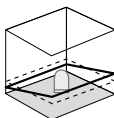
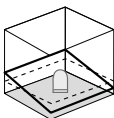

### Justering af Y-aksen op til max 2°

LED'en hældningsfunktion (18) blinker langsomt.

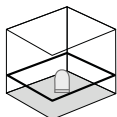

3 sek.

1 sek.

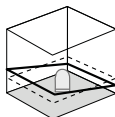
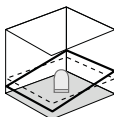

## Justering af begge akser

X-akse: LED'en hældningsfunktion (18) blinker hurtigt.

Y-akse: LED'en hældningsfunktion (18) blinker langsomt.

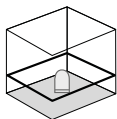

3 sek.

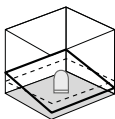

1 sek.

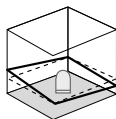

## 7 Indstilling af vertikal hældning, op til max 2° (X, Y-akse)

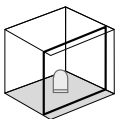
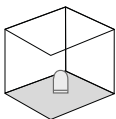
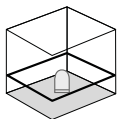

3 sek.

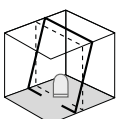
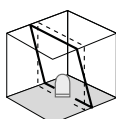

## 8 Faldfunktion > 2°

Større hældninger kan anlægges med vinkelpladen (ekstraudstyr), art.-nr. 080.75. Hertil anvendes et stativ med håndsving, fx. stativ med håndsving P 300 cm, art.-nr. 080.34. Se nedenstående figurer.

TIP: Først stiller man vinkelpladen på nul og lader derefter apparatet indjustere sig automatisk. Sluk derefter sensor-automatikken med knappen 14 (hældningsfunktion TIL). Endelig hælder man apparatet i den ønskede vinkel.

## Indstil hældning > 2°

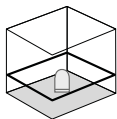

3 sek.



## 9 Håndmodtagermodus

### Ekstraudstyr: Arbejdet med lasermodtageren RX

Brug af laser modtager RX (ekstraudstyr) til at udføre nivellering over store afstande, eller når laserlinjer ikke længere er synlige. For at arbejde med lasermodtageren skal man sætte linjelaseren i håndmodtagermodus ved at trykke på tasten 14 (håndmodtagermodus tændt / slukket). Laseren linjer vil nu pulserede med høj frekvens, hvilket gør laserlinjer mørkere. Laseren modtager kan opfange disse pulserende laser linjer.



1 sek.



**!** Overhold lasermodtager betjeningsvejledningen for linje lasere.

**!** Pga. den specielle optik til generering af en gennemgående 360° laserlinje kan der af tekniske årsager forekomme varierende lysstyrke i forskellige områder af linjen. Dette kan medføre forskellige rækkevidder i håndmodtagermodus.

## EU-bestemmelser og bortskaffelse

Apparatet opfylder alle påkrævede standarder for fri vareomsætning inden for EU.

Dette produkt er et elapparat og skal indsamles og bortskaffes separat i henhold til EF-direktivet for (brugte) elapparater.

Flere sikkerhedsanvisninger og supplerende tips på:

[www.laserliner.com/info](http://www.laserliner.com/info)

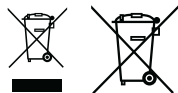

## Forberedelse til kontrol af retvisning

Skal laserens retvisning kontrolleres - hvilket bør gøres med jævne mellemrum - opstilles laseren **midt** mellem 2 vægge med en indbyrdes afstand på mindst 5 meter og tændes. Slå transportsikringen fra og tænd for instrumentet (**laser-krydset aktiveres**). Brug hertil et stativ.

1. Markér laserplanet A1 på væggen.
2. Drej laseren nøjagtig 180° og marker laserplanet A2 på den modstående væg. Da laseren er placeret nøjagtig midt mellem de 2 vægge, vil markeringerne A1 og A2 være nøjagtig vandret overfor hinanden.

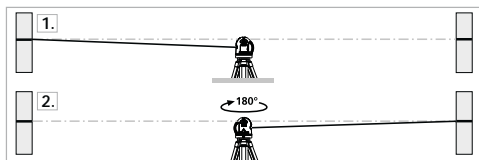

## Kontrol af retvisning

3. Anbring apparatet så tæt til væggen som muligt i højde med det markerede punkt A1.
4. Drej apparatet 180°, og marker punktet A3. Forskellen mellem A2 og A3 er tolerancen.

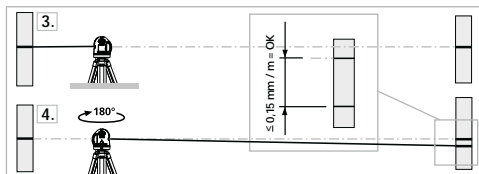

**!** Hvis A2 og A3 ligger mere end 0,15 mm / m fra hinanden, skal der foretages en justering. Indlevér laseren til forhandleren, som sørger for det videre fornødne, eller kontakt serviceafdelingen hos UMAREX-LASERLINER.

## Kontrol af lodret laserlinie

Laseren opstilles ca. 5 m fra en væg. På væggen ophænges et snorelod med 2,5 m snor, således at det hænger frit. Den lodrette laserstråle tændes, laseren sigtes ind, så den lodrette laserstråle flugter med snoren, og det kontrolleres, at linien ikke afviger mere end  $\pm 0,75$  mm fra snoren.

## Kontrol af vandret laserlinie

Laseren opstilles ca. 5 m fra en væg, og det vandrette laserkryds tændes. Krydspunktet markeres på væggen, hvorefter laserkrydset drejes ca. 2,5 m til højre. Den vandrette streg må ikke afvige mere end  $\pm 0,75$  mm fra markeringen af krydspunktet. Proceduren gentages med laserkrydset drejet 2,5 m til venstre.

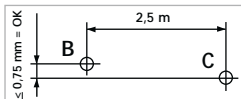

- ! Kontrollér regelmæssigt – og altid før påbegyndelsen af en ny opgave laserens retvisning.

## Tekniske data (Forbehold for tekniske ændringer. 02.17)

Selvnivelleringsområde	$\pm 2^\circ$
Nøjagtighed	$\pm 0,15$ mm / m
Rækkevidde (afhængig af lysforhold)	20 m
Arbejdsområde med håndmodtager (afhængig af teknisk relateret lysstyrkeforskel)	30 m
Laserbølgelængde linjelaser	635 nm
Laser klasse	2 / < 1 mW
Strømforsyning	Lithium-ion-batteripakke 7,4 V / 2600 mA Anvendelse af lysnetadapter
Drifttid med 3 laserniveauer med 2 laserniveauer med 1 laserniveau	ca. 7 timer ca. 10 timer ca. 15 timer
Arbejdstemperatur	0°C ... +50°C
Opbevaringstemperatur	-10°C ... +70°C
Mål (b x h x l)	180 x 145 x 125 mm
Vægt (inkl. batteripakke)	1,51 kg



Lisez entièrement le mode d'emploi et le carnet ci-joint «Remarques supplémentaires et concernant la garantie» cjointes. Suivez les instructions mentionnées ici. Conservez ces informations et les donner à la personne à laquelle vous remettez le dispositif laser.

## Fonction / Emploi prévu

Laser tridimensionnel avec trois cercles laser rouges de 360° et un socle métallique adaptable

- Fonction d'inclinaison supplémentaire pour ajuster les inclinaisons
- Réglage motorisé possible de  $\pm 2^\circ$
- Out-Off-Level : les signaux optiques avertissent l'utilisateur de l'appareil lorsque ce dernier se trouve au-delà de la plage d'auto-nivellement.
- Socle métallique adapté pour un positionnement précis des lignes laser grâce au boîtier orientable à commande latérale de précision.
- Plage de mise à niveau automatique  $2^\circ$ , précision 0,15 mm / m

## Consignes de sécurité générales

- Utiliser uniquement l'instrument pour l'emploi prévu dans le cadre des spécifications.

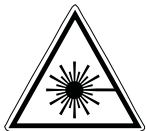

Rayonnement laser!  
Ne pas regarder dans le faisceau.  
Appareil à laser de classe 2  
< 1 mW · 635 nm  
EN 60825-1:2014

- Attention : Ne pas regarder le rayon direct ou réfléchi.
- Ne pas diriger le rayon laser sur des personnes.
- Si le rayonnement laser de la classe 2 touche les yeux, fermez délibérément les yeux et tournez immédiatement la tête loin du rayon.
- Ne jamais regarder le faisceau laser ni les réflexions à l'aide d'instruments optiques (loupe, microscope, jumelles, etc.).
- Ne pas utiliser le laser à hauteur des yeux (entre 1,40 et 1,90 m).
- Couvrir les surfaces brillantes, spéculaires et bien réfléchissantes pendant le fonctionnement des dispositifs laser.

- Lors de travaux sur la voie publique, limiter, dans la mesure du possible, la trajectoire du faisceau en posant des barrages et des panneaux. Identifier également la zone laser en posant un panneau d'avertissement.
- Il est interdit de manipuler (modifier) le dispositif laser.
- Cet appareil n'est pas un jouet et ne doit pas être manipulé par des enfants.

## Caractéristiques particulières du produit



Mise à niveau automatique des appareils garantie par des nivelles électroniques et des servomoteurs équipés de capteurs à stabilité thermique. L'instrument est mis en position initiale et s'oriente de manière autonome.



Cette fonction est activée automatiquement, lors que le Sensor Automatic est allumé. Ceci facilite le nivellement horizontal et vertical, par ex., pour positionner le laser à la hauteur souhaitée sur un trépied ou un support mural. Cela permet également de niveller sur un support vibrant ou par temps venteux.



Transport LOCK: L'instrument est protégé par un frein moteur spécial pendant le transport.



Les diodes spéciales de très grande puissance produisent des lignes encore plus lumineuse que les lasers avec la technologie PowerBright. C'est pourquoi, elles restent visibles sur de très grandes longueurs, aussi bien dans un environnement très lumineux, que sur des surfaces sombres.



La technologie RX-READY permet d'utiliser les lasers à lignes même en cas de visibilité moins favorable. Les lignes laser sont soumises à des pulsations de haute fréquence et donc sont visibles sur de grandes distances grâce aux récepteurs laser spéciaux.

## Quantité et direction des lasers

H = ligne laser horizontale

V = ligne laser verticale

S = Inclinaisons

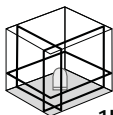

1H360° 2V360°



S

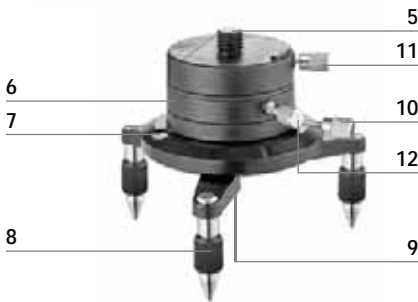

- 1 Fenêtre de sortie du rayon laser
- 2 Compartiment à accu (dos)
- 3 Prise de branchement du bloc secteur (12 V / 2000mA, pas de fonction charge)
- 4 Filet pour trépied de 5/8 po (dos)
- 5 Douille fileté de 5/8 po
- 6 Socle entièrement mobile
- 7 Bulle sphérique
- 8 Pieds d'ajustage
- 9 Filet pour trépied de 5/8 po
- 10 Dispositif d'arrêt
- 11 Vis de fixation de la douille fileté
- 12 Commande latérale de précision



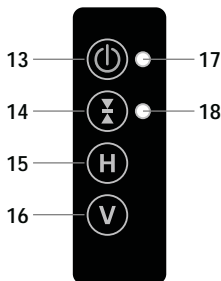

- 13 Touche MARCHE/ARRET
- 14 Mode récepteur manuel activé / désactivé / Fonction d'inclinaison activée
- 15 Lignes laser horizontales
- 16 Lignes laser verticales
- 17 DEL d'affichage du fonctionnement / Mode de fonctionnement automatique (la DEL clignote dans la phase de réglage)
- 18 DEL mode récepteur manuel / DEL de la fonction d'inclinaison

## 1 Utilisation de l'accu Li-ion

Charger complètement la batterie avant la première utilisation. Pour cela, mettre l'accu dans le chargeur fourni avec l'appareil. Veillez à insérer l'accu dans le bon sens. Pendant la recharge de l'accu, la DEL du chargeur s'allume en rouge. Le processus de charge est terminé lorsque la DEL s'allume en vert. La charge de l'accu est faible dès que les DEL (17) et (18) clignotent. L'appareil s'éteint automatiquement si la charge de l'accu est très faible. Recharger ensuite à nouveau l'accu.

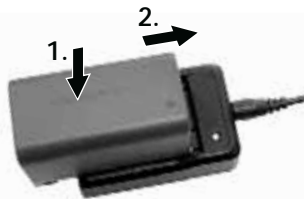

! L'accu ne doit être chargé **qu'à** l'aide du chargeur fourni et être utilisé exclusivement **avec ce** dispositif laser pour éviter tout risque de blessure et d'incendie.

! Assurez-vous qu'aucun objet conducteur ne se trouve à proximité des contacts de l'accu. Un court-circuit de ces contacts peut entraîner des brûlures et un incendie.

! Pour éviter tout risque de court-circuit, n'ouvrez pas l'accu.

## 2 Alimentation électrique

### Introduire l'accu lithium-ion

Ouvrir le compartiment à accu et introduire l'accu lithium-ion comme illustré ci-contre.



### Utilisation avec le bloc d'alimentation électrique/chargeur

L'appareil peut être utilisé avec le bloc d'alimentation électrique/chargeur également fourni.



L'accu ne se charge pas pendant le fonctionnement sur secteur.

## 3 Positionner les lignes laser

Le socle métallique adapté permet de positionner avec précision les lignes laser.



- A Desserrer la vis de fixation de la douille fileté (11).
- B Retirer la douille fileté de 5/8 po (5) et la visser dans le filetage pour trépied de 5/8 po (4) de l'appareil
- C Poser l'appareil avec la douille fileté de 5/8 po sur le socle métallique, puis le fixer en utilisant la vis de fixation



L'appareil doit s'encliquer dans la rainure (D) pour être parfaitement fixé.

## Réglage au moyen du socle entièrement mobile

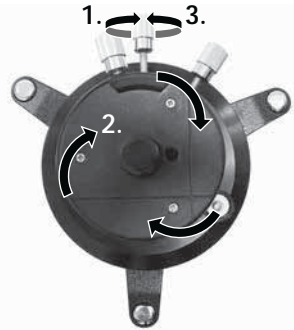

## Réglage au moyen de la commande latérale de précision

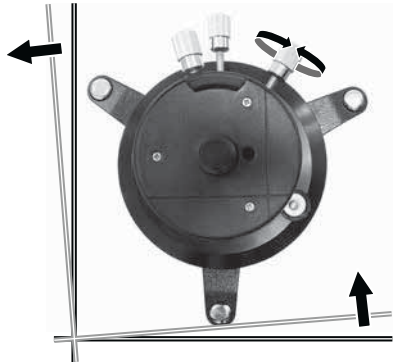

## 4 Nivellements horizontal et vertical

Mettre le dispositif laser en marche. Senso-Automatik est maintenant activé et nivelle automatiquement le dispositif laser. Dès que le nivellement est terminé et que la DEL auto est allumée en permanence, il est possible de procéder au nivellement horizontal ou vertical. Il est possible d'atteindre la précision maximale une fois le nivellement terminé.

Il est possible d'activer ou de désactiver individuellement les lasers en appuyant brièvement sur la touche H ou V.

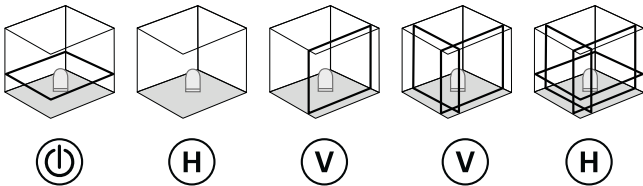

**!** Dès que l'appareil se trouve en dehors de la plage de nivellement automatique de 2°, les lignes laser clignotent. Positionner l'instrument de manière à ce qu'il soit dans la plage de nivellement.

## 5 Fonction d'inclinaison jusqu'à 2° au maximum

L'activation de la fonction d'inclinaison permet de désactiver le Sensor-Automatic. Appuyer longuement sur la touche 14 (fonction d'inclinaison activée) jusqu'à ce que la DEL de la fonction d'inclinaison (18) clignote rapidement. Il est maintenant possible de régler l'inclinaison de manière motorisée. Appuyer en permanence sur la touche H ou V pour régler l'inclinaison. La zone d'inclinaison maximale est atteinte lorsque les lasers clignent. Il suffit d'appuyer brièvement sur la touche 14 pour commuter entre les axes. La DEL de la fonction d'inclinaison (18) clignote lentement.

Les lignes laser ne sont plus orientées à l'horizontale ou à la verticale en fonction d'inclinaison. Cela est particulièrement le cas des lignes laser déréglées. Désactiver la fonction d'inclinaison pour procéder au nivellement horizontal ou vertical. Pour cela, mettre l'appareil hors tension puis de nouveau sous tension ou appuyer longuement sur la touche 14 (fonction d'inclinaison activée) jusqu'à ce que les lignes laser se déplacent automatiquement.

## 6 Régler l'inclinaison horizontale, jusqu'à 2° au max. (axes X et Y)

### Réglage de l'axe X jusqu'à 2° au maximum

La DEL de la fonction d'inclinaison (18) clignote rapidement.

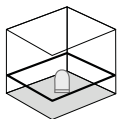

3 s

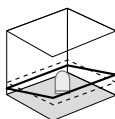
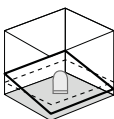

### Réglage de l'axe Y jusqu'à 2° au maximum

La DEL de la fonction d'inclinaison (18) clignote lentement.

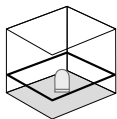

3 s

1 s

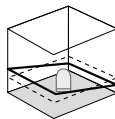
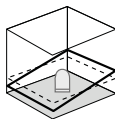

## Réglage des deux axes

Axe X: La DEL de la fonction d'inclinaison (18) clignote rapidement.

Axe Y: La DEL de la fonction d'inclinaison (18) clignote lentement.

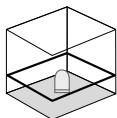

3 s

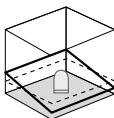

1 s

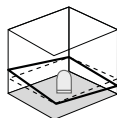

## 7 Régler l'inclinaison verticale, jusqu'à 2° au maximum (axes X et Y)

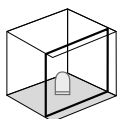
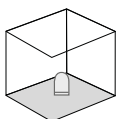
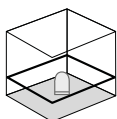

3 s

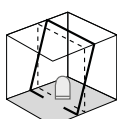
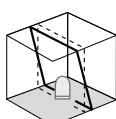

## 8 Fonction d'inclinaison > 2°

Il est possible de projeter de plus grandes inclinaisons en utilisant la plaque angulaire, réf. 080.75. Pour cela, utiliser un trépied à manivelle, par ex. trépied à manivelle P 300 cm, réf. 080.39. Voir les illustrations suivantes.

CONSEIL: régler tout d'abord la plaque angulaire sur zéro et laisser l'appareil s'orienter automatiquement. Désactiver ensuite la fonction Sensor Automatic en appuyant sur la touche 14 (fonction d'inclinaison activée). Incliner ensuite l'appareil à l'angle souhaité.

### Régler l'inclinaison > 2°

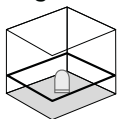

3 s



**9**  **Mode récepteur manuel**

**En option : Fonctionnement avec le récepteur de laser RX**

Utiliser un récepteur de laser RX (en option) pour le nivellement sur de grandes distances ou en cas de lignes laser qui ne sont plus visibles. Mettre le laser à lignes en mode récepteur manuel en appuyant sur la touche 14 (mode récepteur manuel activé / désactivé) pour pouvoir travailler avec le récepteur laser. Les lignes laser sont soumises à des pulsations de haute fréquence et les lignes laser deviennent plus sombres. A partir de ces pulsations, le récepteur de laser reconnaît les lignes laser.



**!** Tenir compte du mode d'emploi du récepteur laser pour le laser à lignes.

**!** Un rapport de diversité de nature technique peut se produire dans différentes zones de la ligne en raison de l'optique spéciale générant une ligne laser continu de 360°. Cela peut conduire à des portées différentes dans le mode récepteur manuel.

**Réglementation UE et élimination des déchets**

L'appareil est conforme à toutes les normes nécessaires pour la libre circulation des marchandises dans l'Union européenne.

Ce produit est un appareil électrique et doit donc faire l'objet d'une collecte et d'une mise au rebut sélectives conformément à la directive européenne sur les anciens appareils électriques et électroniques (directive DEEE).

Autres remarques complémentaires et consignes de sécurité sur [www.laserliner.com/info](http://www.laserliner.com/info)



## Préliminaires au contrôle du calibrage

Vous pouvez contrôler le calibrage du laser. Posez l'appareil au **centre** entre deux murs écartés l'un de l'autre d'au moins 5 m. Éteindre l'instrument en dégageant le blocage du transport (**croix laser allumée**). Utilisez un trépied pour un contrôle optimal.

1. Marquez un point A1 sur le mur.
2. Tournez l'appareil de 180° et marquez un point A2. Vous disposez donc entre les points A1 et A2 d'une ligne de référence horizontale.

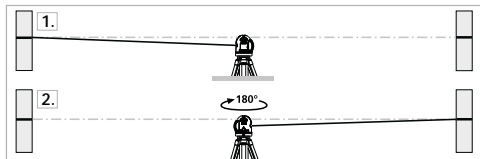

## Contrôler le calibrage

3. Rapprochez l'appareil aussi près que possible du mur à hauteur du repère A1.
4. Tournez l'appareil de 180° et repérez un point A3. La différence entre les points A2 et A3 est la tolérance.

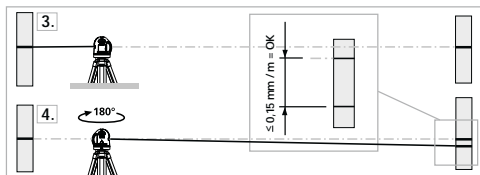

! Un calibrage est nécessaire si A2 et A3 sont écartés l'un de l'autre de plus de 0,15 mm / m. Prenez contact avec votre revendeur ou appelez le service après-vente de UMAREX-LASERLINER.

## Vérification de la ligne verticale

Placez l'appareil à env. 5 m d'un mur. Fixez sur le mur un fil d'aplomb avec une corde de 2,5 m de longueur. Le fil d'aplomb doit alors pendre librement. Allumez l'appareil et aligner le laser vertical sur le fil d'aplomb. La tolérance de précision est respectée lorsque l'écart différence entre la ligne laser et le fil d'aplomb ne dépasse pas  $\pm 0,75$  mm.

## Vérification de la ligne horizontale

Installez l'appareil à env. 5 m d'un mur et allumez

le laser croisé. Marquez le point B sur le mur.

Faites pivoter le laser croisé d'env. 2,5 m. vers

la droite et marquer le point C. Vérifiez si la

ligne horizontale du point C se trouve à  $\pm 0,75$  mm à la même hauteur que

le point B. Répétez l'opération en faisant pivoter vers la gauche.

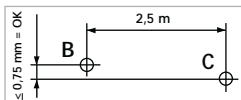

**!** Vérifier régulièrement le calibrage avant utilisation, à la suite d'un transport ou d'une longue période de stockage.

## Données techniques (Sous réserve de modifications techniques. 02.17)

Plage de mise à niveau automatique	$\pm 2^\circ$
Précision	$\pm 0,15$ mm / m
Plage de travail (dépend de la luminosité dans le local)	20 m
Zone de travail avec le récepteur manuel (dépend du rapport de diversité de nature technique)	30 m
Longueur de l'onde lignes laser	635 nm
Classe de laser	2 / < 1 mW
Alimentation électrique	Pack d'accu Li-ion 7,4 V / 2600 mA Fonctionnement avec le bloc d'alimentation
Durée de fonctionnement avec trois plans de laser	env. 7 h
avec deux plans de laser	env. 10 h
avec un plan de laser	env. 15 h
Température de fonctionnement	0°C ... +50°C
Température de stockage	-10°C ... +70°C
Dimensions (l x h x p)	180 x 145 x 125 mm
Poids (pack d'accu compris)	1,51 kg





Lea atentamente las instrucciones de uso y el pliego adjunto „Garantía e información complementaria“. Siga las instrucciones indicadas en ellas. Conserve esta documentación y entréguela con el dispositivo si cambia de manos.

## Funcionamiento y uso

Láser tridimensional con tres círculos láser de 360° rojos y base de metal regulable

- Modo de inclinación adicional para la orientación en planos inclinados
- Posibilidad de ajuste motorizado de  $\pm 2^\circ$
- Out-Off-Level: el aparato indica que se encuentra fuera del rango de nivelación mediante señales ópticas.
- Base de metal regulable para el exacto posicionamiento de las líneas láser girando la carcasa, con accionamiento lateral de precisión.
- Margen de auto-nivelado  $2^\circ$ , precisión 0,15 mm / m

## Indicaciones generales de seguridad

- Utilice el aparato únicamente para los usos previstos dentro de las especificaciones.

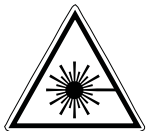

Rayo láser!  
¡No mire al rayo láser!  
Láser clase 2  
< 1 mW · 635 nm  
EN 60825-1:2014

- Atención: No mire directamente el rayo ni su reflejo.
- No oriente el rayo láser hacia las personas.
- Si el rayo láser de clase 2 se proyecta en los ojos, ciérrelos inmediatamente y aparte la cabeza de su trayectoria.
- No mire nunca el rayo láser o las reflexiones con aparatos ópticos (lupa, microscopio, prismáticos, ...).
- No utilice el láser a la altura de los ojos (1,40 ... 1,90 m).
- Durante el uso de un equipo láser hay que cubrir necesariamente todas las superficies reflectantes, especulares o brillantes.

- En zonas de tráfico públicas debe limitarse el recorrido de los rayos dentro de lo posible mediante barreras o tabiques móviles y marcar la zona de trabajo con láser con placas de advertencia.
- No está permitido manipular (alterar) este dispositivo.
- Este dispositivo no es ningún juguete y no debe encontrarse al alcance de los niños.

## Características especiales



Alineación automática mediante niveles electrónicos y servomotores con sistema sensorico estable a la temperatura. Una vez colocado el aparato en la posición básica éste se alinea automáticamente.



Esta función se activa automáticamente cuando está encendido Sensor-Automatic. Sirve para facilitar la nivelación horizontal o vertical, por ejemplo para ajustar el láser a una altura determinada con un trípode de manivela o con un soporte de pared. Permite además nivelar sobre suelos sometidos a vibraciones y con viento.



**BLOQUEO de transporte:** el aparato cuenta con un freno especial del motor como protección para el transporte.



Los diodos especiales de alto rendimiento generan unas líneas láser más nítidas que los aparatos con tecnología PowerBright. Las líneas son visibles a largas distancias, en condiciones de abundante luz ambiental y sobre superficies oscura.



La tecnología RX-READY hace posible el uso de los láser de líneas también con malas condiciones de luz. En esos casos las líneas láser vibran con una alta frecuencia y son detectadas a grandes distancias por los receptores de láser especiales.

## Número y disposición de los láseres

H = línea de láser horizontal

V = línea de láser vertical

S = función de inclinación

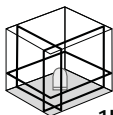

1H360° 2V360°



S

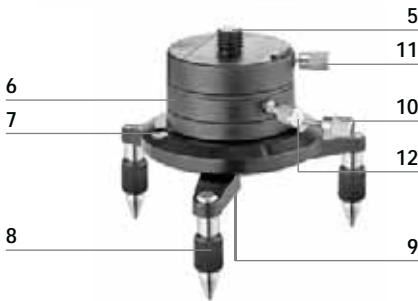

- 1 Ventana de salida láser
- 2 Compartimento para pilas (dorso)
- 3 Casquillo de conexión para fuente de alimentación (12 V / 2000 mA, sin función de carga)
- 4 Conexión de rosca de 5/8" (dorso)
- 5 Pieza roscada de 5/8"
- 6 Base móvil
- 7 Nivel esférico
- 8 Patas regulables
- 9 Conexión de rosca de 5/8"
- 10 Bloqueo
- 11 Pieza roscada con tornillo de fijación
- 12 Rueda de ajuste de precisión

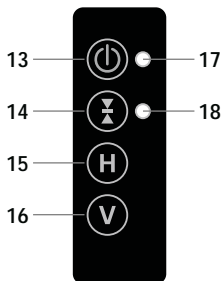

- 13 Tecla de encendido y apagado (ON/OFF)
- 14 Modo de receptor manual Con / Des / Activar función de inclinación
- 15 Líneas láser horizontales
- 16 Líneas láser verticales
- 17 LED de indicación de servicio / automático (LED intermitente en la fase de ajuste)
- 18 Modo de receptor manual LED / LED de la función de inclinación

## 1 Manejo de la batería de iones de litio

Cargar la batería por completo antes de utilizarla por primera vez. Colocar la batería en el cargador suministrado. Prestar atención a la posición correcta de la batería en el cargador. Mientras se carga la pila el LED del cargador está encendido con luz roja. El proceso de carga finaliza cuando el LED cambia a luz verde. La luz intermitente de los LED (17) y (18) indica que la carga de la batería está baja. El aparato se apaga automáticamente cuando la carga de la batería es muy débil. En ese cargo proceda a recargar de nuevo la batería.

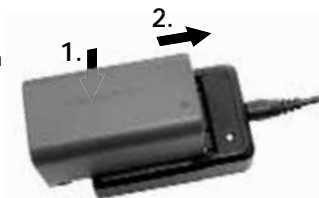

! La batería **sólo** puede ser cargada con el cargador adjunto y utilizada únicamente **con este** aparato láser. De lo contrario existe peligro de accidente y de incendio.

! Obsérvese que no haya ningún objeto conductor cerca de los contactos de la batería. Un cortocircuito de esos contactos puede provocar quemaduras y fuego.

! No abra la batería. Podría provocar un cortocircuito.

## 2 Alimentación

### Utilizar una batería de iones de litio

Abrir el compartimento y colocar la batería de iones de litio como se muestra en la imagen.



### Funcionamiento en red, con el cargador

El aparato puede ser conectado a la red con el cargador adjunto.



**!** La batería no se carga durante el funcionamiento en red.

## 3 Posicionar las líneas láser

La base de metal regulable permite posicionar las líneas láser con precisión.



- A** Aflojar el tornillo de fijación con la pieza roscada (11).
- B** Retirar la pieza roscada de 5/8" (5) y atornillar la rosca del trípode de 5/8" (4) del aparato.
- C** Colocar el aparato con la pieza roscada de 5/8" en la base de metal y sujetarlo con el tornillo de fijación.

**!** Para estar bien fijado, el aparato tiene que encajarse en la ranura (D).

### Ajuste con base móvil

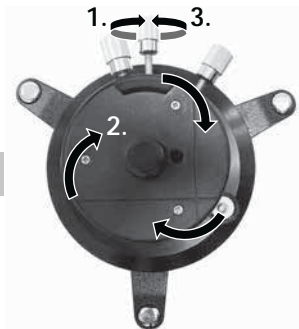

### Ajuste con accionamiento lateral de precisión

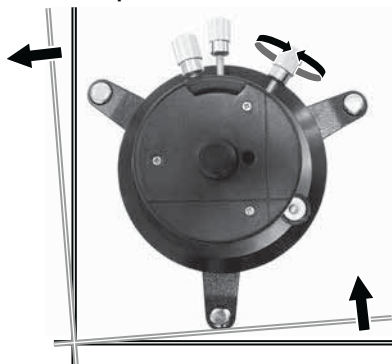

## 4 Nivelación horizontal y vertical

Encender el aparato láser. Ahora está activada la automática de sensor y nivela el aparato láser automáticamente. Al finalizar la nivelación se enciende el LED del modo automático con luz continua y se puede realizar la nivelación horizontal o vertical. La precisión máxima se consigue cuando ha finalizado la nivelación.

Con las teclas H o V se puede encender o apagar por separado los distintos láseres (pulsar la tecla brevemente).

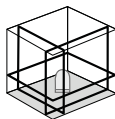
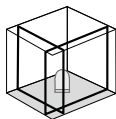
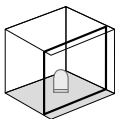
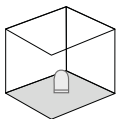
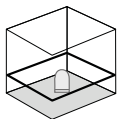

**!** Cuando el aparato se encuentra fuera del rango automático de nivelación de 2°, las líneas láser parpadean. Coloque el aparato en una posición dentro del rango de nivelación.

## 5 Función de inclinación, hasta máx. 2°

Cuando se activa la función de inclinación se desactiva la automática del sensor. Pulsar para ello el botón 14 (activar la función de inclinación) hasta que el LED de la función de inclinación (18) parpadee con rapidez. Ahora ya se puede ajustar la inclinación por motor. Mantener pulsados los botones H o V para ajustar la inclinación. Cuando los láseres comienzan a parpadear indican que se ha alcanzado el rango máximo de inclinación. El botón 14 (pulsación breve) invierte los ejes. El LED de la función de inclinación (18) parpadea despacio.

**!** Con la función de inclinación las líneas láser ya no están alineadas horizontal sino verticalmente. Esto rige especialmente para las líneas láser reajustadas. Para una nivelación horizontal o vertical desactive primero la función de inclinación. Para ello, apagar y encender el aparato o mantener pulsado el botón 14 (activar la función de inclinación) hasta que las líneas láser se muevan automáticamente.

## 6 Ajuste de la inclinación horizontal, hasta un máx. de 2° (ejes X, Y)

### Ajuste del eje X hasta un máximo de 2°

El LED de la función de inclinación (18) parpadea rápido.

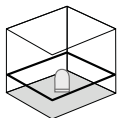

3 seg.

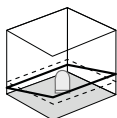
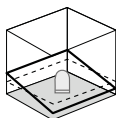

### Ajuste del eje Y hasta un máximo de 2°

El LED de la función de inclinación (18) parpadea despacio.

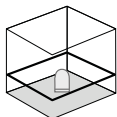

3 seg.

1 seg.

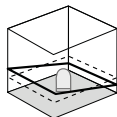
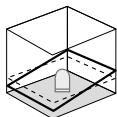

## Variar ambos ejes

Eje X: El LED de la función de inclinación (18) parpadea rápido.

Eje Y: El LED de la función de inclinación (18) parpadea despacio.

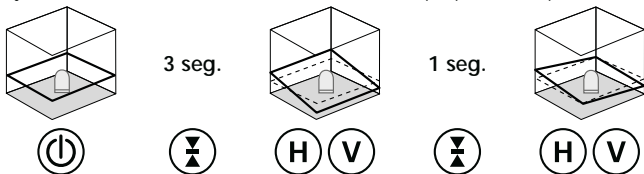

## 7 Ajuste de la inclinación vertical, hasta un máx. de 2° (ejes X, Y)

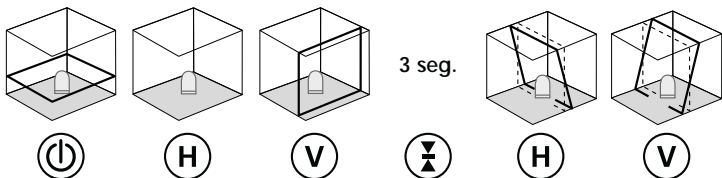

## 8 Función de inclinación > 2°

Mayores inclinaciones pueden realizarse con la plantilla opcional, n° de art. 080.75. Para ello use un trípode de manivela, p. ej trípode de manivela P 300 cm, n° de art. Observe las figuras siguientes.

CONSEJO: en primer lugar cambie la plantilla angular a cero para dejar que el aparato se alinee automáticamente. Luego, apagar Sensor-Automatic con el botón 14 (activar la función de inclinación). A continuación incline el aparato al ángulo deseado.

### Ajuste de inclinación > 2°

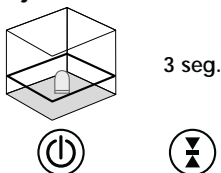



## 9 Modo de receptor manual

### Opcional: Trabajar con el receptor láser RX

Utilice un receptor de láser RX (opcional) para nivelar a grandes distancias o para líneas láser no visibles. Para trabajar con el receptor de láser, cambie el láser de líneas al modo de receptor manual pulsando la tecla 14 (modo de receptor manual On / Off). Ahora las líneas láser emiten pulsaciones con una elevada frecuencia y las líneas láser se oscurecen. El receptor de láser detecta las líneas de láser con ayuda de esas pulsaciones.



**!** Siga las instrucciones de uso del receptor de láser para los láser de líneas.

**!** Debido a la especial óptica para generar una línea láser de 360° continua pueden producirse diferencias de intensidad, condicionadas por la técnica, en diferentes zonas de la línea. Esto puede provocar diferencias en los alcances en el modo de receptor manual.

## Disposiciones europeas y eliminación

El aparato cumple todas las normas requeridas para el libre tráfico de mercancías en la UE.

Se trata de un aparato eléctrico, por lo que debe ser recogido y eliminado por separado conforme a la directiva europea relativa a los aparatos eléctricos y electrónicos usados.

Más información detallada y de seguridad en:

[www.laserliner.com/info](http://www.laserliner.com/info)

**CE**

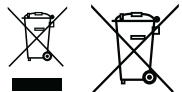

## Preparativos para la comprobación de la calibración

Usted mismo puede comprobar la calibración del láser. Coloque el aparato en el **medio** entre 2 paredes, separadas como mínimo 5 m. Encienda el aparato, suelte para ello el seguro de transporte (**cruz de láser activado**). Para una comprobación óptima, por favor utilice un trípode / soporte.

1. Marque el punto A1 en la pared.
2. Gire el aparato 180° y marque el punto A2.  
Ahora tiene una referencia horizontal entre A1 y A2.

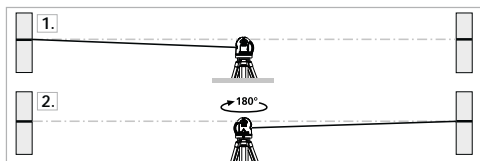

## Comprobar la calibración

3. Ponga el aparato lo más cerca posible de la pared, a la altura del punto A1 marcado.
4. Gire el aparato 180° y marque el punto A3.  
La diferencia entre A2 y A3 es la tolerancia.

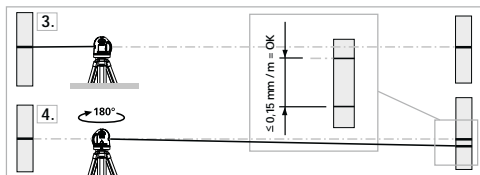

**!** Si los puntos A2 y A3 están separados más de 0,15 mm / m, es necesario efectuar una calibración. Póngase en contacto con su distribuidor especializado o diríjase al Servicio Técnico de UMAREX-LASERLINER.

## Control de la línea vertical

Coloque el aparato a unos 5 m de una pared. Fije una plomada con una cuerda de 2,5 m en la pared, la plomada debe poderse mover libremente. Conecte el aparato y oriente el láser vertical según la cuerda de plomada. La precisión se encuentra dentro de la tolerancia si la desviación entre la línea de láser y la cuerda de plomada no supera los  $\pm 0,75$  mm.

## Control de la línea horizontal

Coloque el aparato a unos 5 m de una pared y conecte la cruz del láser. Marque el punto B en la pared. Gire la cruz de láser unos 2,5 m hacia la derecha. Verifique si la línea horizontal del punto C se encuentra  $\pm 0,75$  mm en la misma altura que el punto B. Repita el proceso, pero ahora girando la cruz de láser hacia la izquierda.

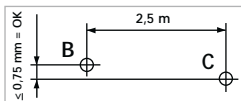

**!** Compruebe regularmente la calibración antes del uso, después de los transportes y después de almacenajes prolongados.

## Datos técnicos (Sujeto a modificaciones técnicas. 02.17)

Margen de auto-nivelado	$\pm 2^\circ$
Precisión	$\pm 0,15$ mm / m
Alcance (depende de la claridad del cuarto)	20 m
Rango de trabajo con el receptor manual (según diferencias de intensidad condicionadas por la técnica)	30 m
Longitud de onda del láser, Láser de líneas	635 nm
Clase láser	2 / < 1 mW
Alimentación	Batería de iones de litio 7,4 V / 2600 mA Funcionamiento con fuente de alimentación
Autonomía de trabajo con 3 niveles de láser con 2 niveles de láser con 1 nivel de láser	aprox. 7 h aprox. 10 h aprox. 15 h
Temperatura de trabajo	0°C ... +50°C
Temperatura de almacenaje	-10°C ... +70°C
Dimensiones (An x Al x F)	180 x 145 x 125 mm
Peso (batería incluida)	1,51 kg

# PrecisionPlane-Laser 3D Pro

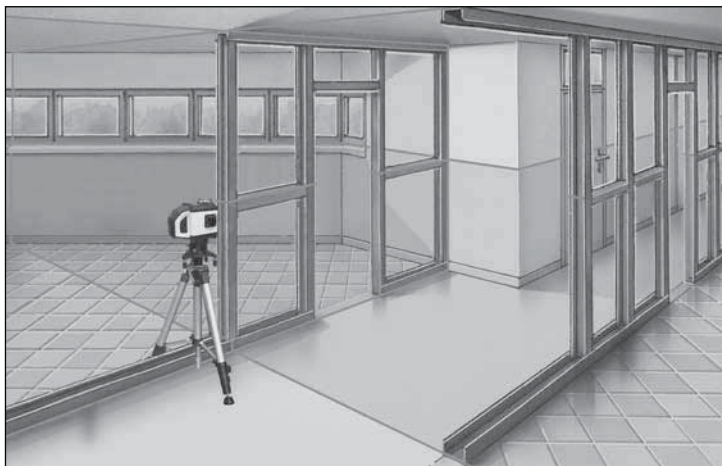

SERVICE



**Umarex GmbH & Co. KG**

– Laserliner –

Möhnestraße 149, 59755 Arnsberg, Germany

Tel.: +49 2932 638-300, Fax: +49 2932 638-333

laserliner@umarex.de

8.036.96.33.1 / Rev0217

Umarex GmbH & Co. KG

Donnerfeld 2

59757 Arnsberg, Germany

Tel.: +49 2932 638-300, Fax: -333

www.laserliner.com



**Laserliner®**